



## **I-70 Mountain Corridor Chain Station Plan**

November 2008



## I-70 Mountain Corridor Chain Station Plan

<b>Introduction</b> .....	<b>3</b>
<b>Vision for the Chain Stations</b> .....	<b>4</b>
<b>Baseline Conditions</b> .....	<b>5</b>
<b>Existing Chain Station Graphics</b> .....	<b>10</b>
<b>Recommendations</b> .....	<b>31</b>
<b>Implementation</b> .....	<b>34</b>
<b>Appendix A</b> .....	<b>35</b>
Meeting Minutes.....	36

---



## Introduction

---

The Colorado Legislature recently updated the State's chain law. This updated law put into effect stricter fines for truck drivers who do not use chains when the chain law is in effect. This updated law went into effect on Saturday, September 1, 2007. The goal of this legislation is to improve the operation of I-70 during the winter months. I-70 is the major east west interstate and disruptions in operations have major impacts on the users, businesses, and communities that are adjacent to I-70.

There must be snow pack on the road surface before trucks can have chains on their tires or damage to the chains and the roadway surface will result. This requires chain stations to be available in close proximity to the locations where the chain law is put into effect. As a result, there was a need for more chain stations. That is why additional chain stations have recently been constructed in the I-70 Mountain Corridor between Denver near C-470 and the Town of Vail. The Colorado Department of Transportation (CDOT) staff was responsible for planning, design, and construction of the existing chain stations. They will also oversee the planned improvements and future improvements of the chain stations.

The purpose of this plan is to provide direction and design standards for future chain stations improvements and new chain stations. Many of the existing chain stations could be impacted as a result of proposed improvements that are currently being studied as part the Programmatic Environmental Impact Study (PEIS) for the I-70 Mountain Corridor. As PEIS improvements are considered and potentially implemented, chain station design will follow the guidance laid out in this plan.

The planning process for the chain stations utilized the I-70 Mountain Corridor Context Sensitive Solutions (CSS) Decision Process. The Colorado Department of Transportation (CDOT) hosted four stakeholder workshops. The purpose of those workshops was to:

- Define desired outcomes and actions
- Endorse the process
- Establish criteria
- Develop alternatives
- Evaluate, select, and refine alternatives

Over fifty stakeholders were involved in the chain station decision process. The stakeholders included community members, jurisdictions, and agencies. The following is a list of jurisdictions and agencies that participated in the process.



Clear Creek County  
Clear Creek EMS  
Clear Creek Fire Authority  
Club 20  
Colorado Department of Transportation  
Colorado Division of Wildlife  
Colorado Motor Carriers Association (CMCA)  
Colorado State Patrol  
East Vail Neighborhood  
Federal Highway Administration (FHWA)  
Georgetown Trust/ Bakerville Heritage Area  
I-70 Coalition

Idaho Springs  
Idaho Springs Police  
Silver Plume  
Silverthorne Police  
State of Colorado Port of Entry  
Summit County  
Town of Frisco  
Town of Georgetown  
Town of Vail  
U.S. Fish & Wildlife Service  
U.S. Forest Service

## Vision for the Chain Stations

---

The goal for the I-70 Mountain Corridor chain stations is to have consistent design standards that will be used and implemented as new chain stations are added to the corridor and existing chain stations are modified. The following is a list of objectives for the chain stations.

### **Improve Safety**

- Add signing that minimizes chaining activities in unsafe locations
- Include a physical separation between the I-70 travel lanes and the chaining areas
- Design a defined exit and entrance points
- Reduce speed limit with ITS signing
- Include additional spaces
- Educate users and increase enforcement
- Consider the safe operations of other interstate functions and chaining facilities
- Whenever possible, design overflow parking to be downstream of the Chain Station area

### **Minimize Environmental Impacts to**

- Noise
- Air quality
- Water quality
- Wildlife



### **Provide Lighting**

- Only during snow storms and when the Chain Law is in effect
- Aid commercial vehicle operators in chaining their vehicles
- Minimize lighting affects on wildlife and residents
- Minimizes maintenance requirements

### **Provide ITS Signing**

- To be in effect only when needed
- To be more noticeable during snow
- Serving multiple purposes – speed limits and information

### **Consider Courtesy Service Program**

- Chains and chaining services
- Towing
- Information
- Snow plowing

## **Baseline Conditions**

---

For the 74 miles along the section of I-70, between Denver near C-470 and the Town of Vail, 20 chain stations have recently been constructed. There are ten chain stations westbound and ten chain stations eastbound. Exhibit 1 shows the locations of the chain stations.

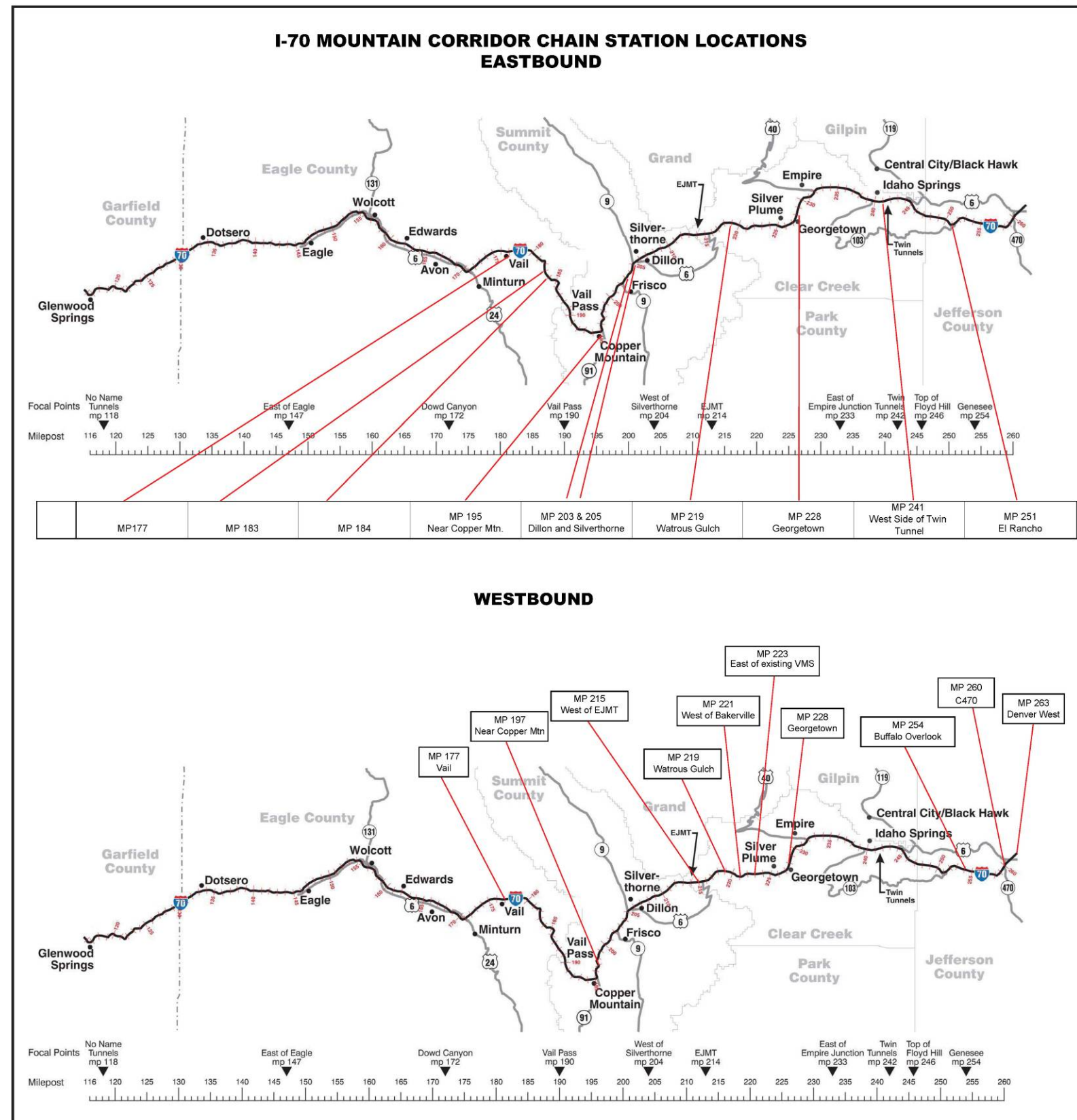
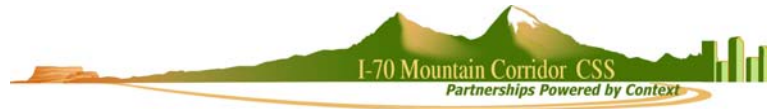

EXHIBIT 1



The following Exhibit 2 is a summary of the existing chain stations that have been constructed in the I-70 Mountain Corridor between Denver near C-470 and the Town of Vail. The exhibit indicates if chain stations were constructed directly adjacent to I-70 or if a physical separation was accommodated. For each chain station, the exhibit details if lighting or signing is currently installed and operational, if the installation of lighting and signing will be constructed as part of a pending project, or if it is a goal for the future when funding becomes available. For each chain station, the exhibit shows if the chain station is located in a Linkage Interference Zone (LIZ). The ALIVE Plan and Memorandum of Understanding (MOU) has identified LIZ as key areas where wildlife cross the I-70 Corridor.

Chain Station	Directly Adjacent to I-70	Separated from I-70	Static Sign	Variable Speed Limit Sign	Lighting	Linkage Interference Zone	# Spaces
Eastbound MP 177- Near Vail	✓		✓	✓	✓		37
Eastbound MP 183	✓		✓	✓	Pending	✓	11
Eastbound MP 184	✓		✓	✓		✓	15
Eastbound MP 187	Eliminated due to direct conflict with proposed wildlife overpass and steep grades						
Eastbound MP 195- Near Copper Mountain	✓		Pending	Pending	Pending		5
Eastbound MP 203- Lake Dillon Scenic Overlook		✓	✓	✓	Future		15
Eastbound MP 205- Silverthorne	✓		✓	✓	Pending		44
Eastbound MP 219- Watrous Gulch		✓	✓	✓	Pending	✓	16
Eastbound MP 228- Georgetown	✓		✓	✓	Future		16
Eastbound	✓		✓	✓	Pending		11

Chain Station	Directly Adjacent to I-70	Separated from I-70	Static Sign	Variable Speed Limit Sign	Lighting	Linkage Interference Zone	# Spaces
MP 241- West side of twin tunnel							
Eastbound MP 251- El Rancho	✓		✓	✓	Future	✓	6
Westbound MP 177- Near Vail	✓		✓	✓	Future		20
Westbound MP 197 Near Copper Mountain		✓	Pending	n/a	Pending	✓	5
Westbound MP 215 – West EJMT		✓	Pending	n/a	High Mast I-70 Tunnel Lighting		6
Westbound MP 219- Watrous Gulch	✓		Pending	Pending	Pending	✓	20
Westbound MP 221- West of Bakerville	✓		✓	Pending	Pending	✓	28
Westbound MP 223 – East of VMS	✓		✓	Future	Future		8
Westbound MP 228- Georgetown		✓	✓	✓	Pending		41
Westbound MP 254- Buffalo Overlook		✓	✓	✓	Future	✓	12



Chain Station	Directly Adjacent to I-70	Separated from I-70	Static Sign	Variable Speed Limit Sign	Lighting	Linkage Interference Zone	# Spaces
Westbound MP 260-C-470 Interchange	✓		✓	✓	Interchange lighting		7
Westbound MP 263-North of 20 <sup>th</sup> Ave	✓		✓	✓	n/a		30
<b>Total</b>	<b>14</b>	<b>6</b>	<b>16</b> <b>Pending 4</b>	<b>14</b> <b>Pending 3</b> <b>Future 1</b>	<b>3</b> <b>Pending 9</b> <b>Future 6</b>	<b>8</b>	<b>290</b>

Notes:

MP – Milepost

Pending- Project is funded and construction will occur within the next year

Future- Project that will be constructed when funding becomes available

EJMT- Eisenhower – Johnson Memorial Tunnel

n/a- Not Applicable

VMS- Variable Message sign



## Existing Chain Station Graphics

---

Exhibit 3-Exhibit 22 show aerial photographs with the chain stations indicated in red and physical separations in yellow. If the aerial photo is new enough to show the chain station improvements, the shape for the chain station and the physical separation are shown as outlines. If the chain stations improvements are not visible in the aerial photo, the chain station and the physical separation are shown as solid shapes. The exhibits also include photos of the chain stations and a table that summarizes the design elements for that location.

Eastbound MP 177- Near Vail



Directly Adjacent to I-70	✓
Static Sign	✓
Variable Speed Limit Sign	✓
Lighting	✓
Linkage Interference Zone	
# Spaces	37



EXHIBIT 3



Directly Adjacent to I-70	✓
Static Sign	✓
Variable Speed Limit Sign	✓
Lighting	Pending
Linkage Interference Zone	✓
# Spaces	11



**EXHIBIT 4**

Eastbound MP 184



Directly Adjacent to I-70	✓
Static Sign	✓
Variable Speed Limit Sign	✓
Lighting	Need electric power
Linkage Interference Zone	✓
# Spaces	15

EXHIBIT 5



PROPOSED CHAIN STATION ELIMINATED DUE TO DIRECT CONFLICT WITH PROPOSED WILDLIFE OVERPASS AND STEEP GRADES

EXHIBIT 6

## Eastbound MP 195- Near Copper Mountain



Directly Adjacent to I-70	✓
Static Sign	Pending
Variable Speed Limit Sign	Pending
Lighting	Pending
Linkage Interference Zone	
# Spaces	5

EXHIBIT 7

### Eastbound MP 203- Dillon Interchange



EB MP 203 Lake Dillon Scenic Overlook



EB MP 205 Silverthorne Interchange

Separated from I-70	✓
Static Sign	✓
Variable Speed Limit Sign	✓
Lighting	Future
Linkage Interference Zone	
# Spaces	15

Directly Adjacent to I-70	✓
Static Sign	✓
Variable Speed Limit Sign	✓
Lighting	Pending
Linkage Interference Zone	
# Spaces	44



EB MP 203 Chain Station



EB MP 205 Chain Station



Eastbound MP 219- Watrous Gulch

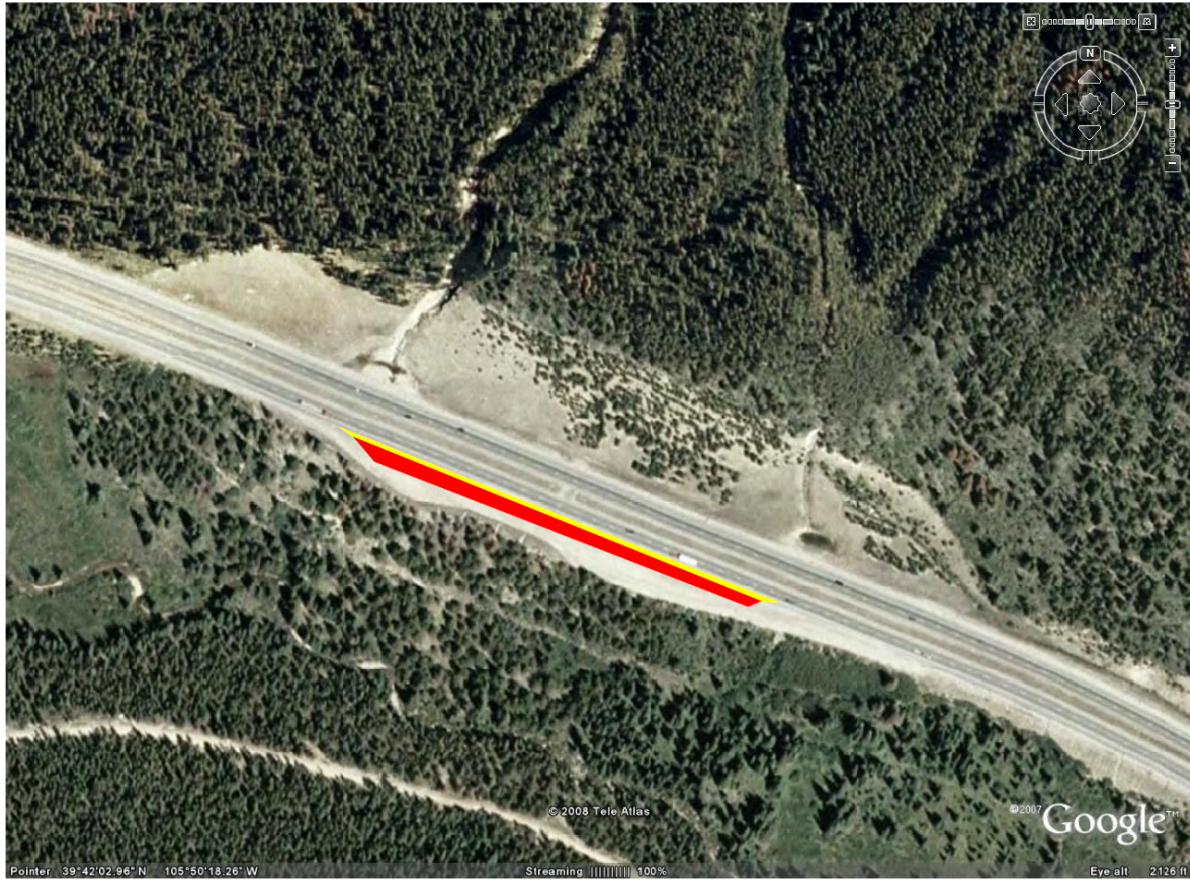

Separated from I-70	✓
Static Sign	✓
Variable Speed Limit Sign	✓
Lighting	Pending
Linkage Interference Zone	✓
# Spaces	16



EXHIBIT 9

**Eastbound MP 228- Georgetown**



Directly Adjacent to I-70	✓
Static Sign	✓
Variable Speed Limit Sign	✓
Lighting	Future
Linkage Interference Zone	
# Spaces	16



Eastbound MP 241- West side of Twin Tunnel



Directly Adjacent to I-70	✓
Static Sign	✓
Variable Speed Limit Sign	✓
Lighting	Pending
Linkage Interference Zone	
# Spaces	11



Eastbound MP 251- El Rancho



Directly Adjacent to I-70	✓
Static Sign	✓
Variable Speed Limit Sign	✓
Lighting	Future
Linkage Interference Zone	✓
# Spaces	6



Westbound MP 177- Near Vail

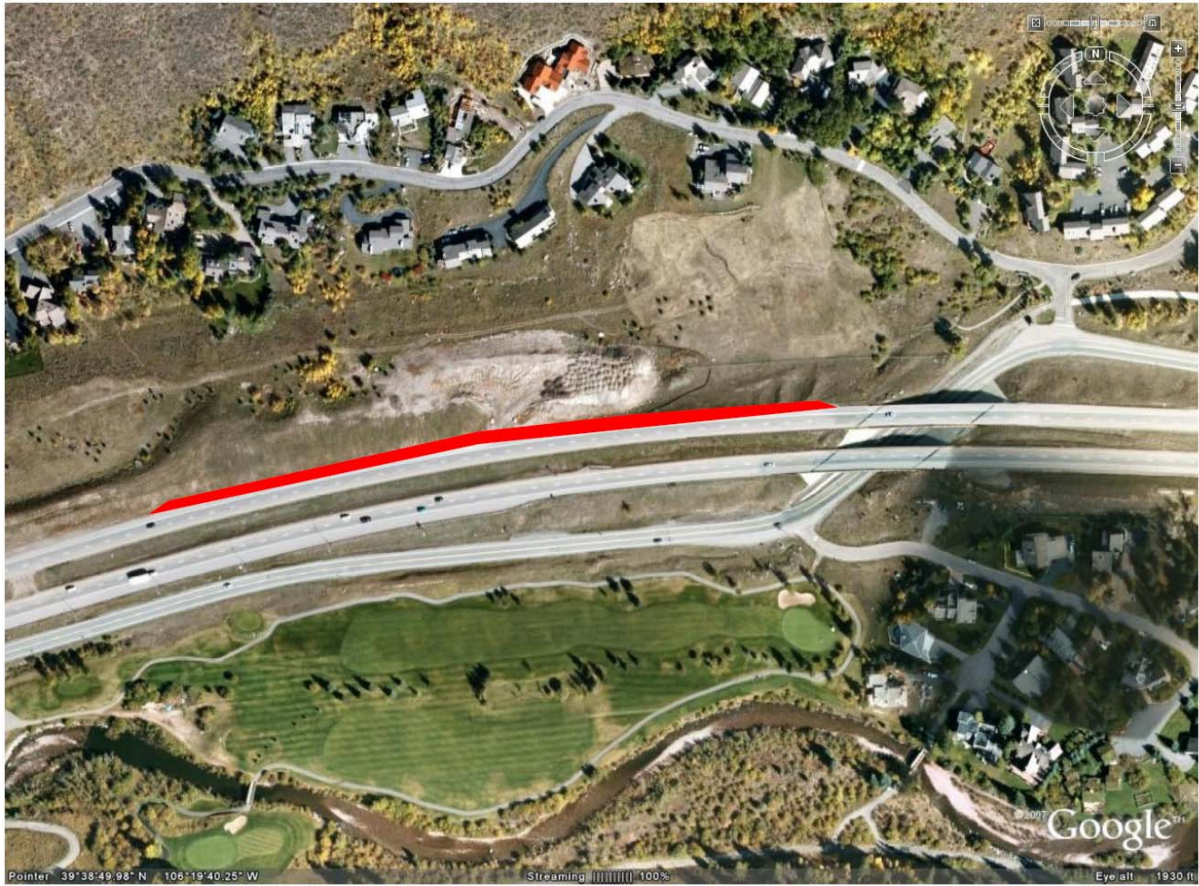

Directly Adjacent to I-70	✓
Static Sign	✓
Variable Speed Limit Sign	✓
Lighting	Future
Linkage Interference Zone	
# Spaces	20



Westbound MP 197- Near Copper Mountain



Separated from I-70	✓
Static Sign	Pending
Variable Speed Limit Sign	n/a
Lighting	Pending
Linkage Interference Zone	✓
# Spaces	5



## Westbound MP 215- West of Eisenhower- Johnson Memorial Tunnel

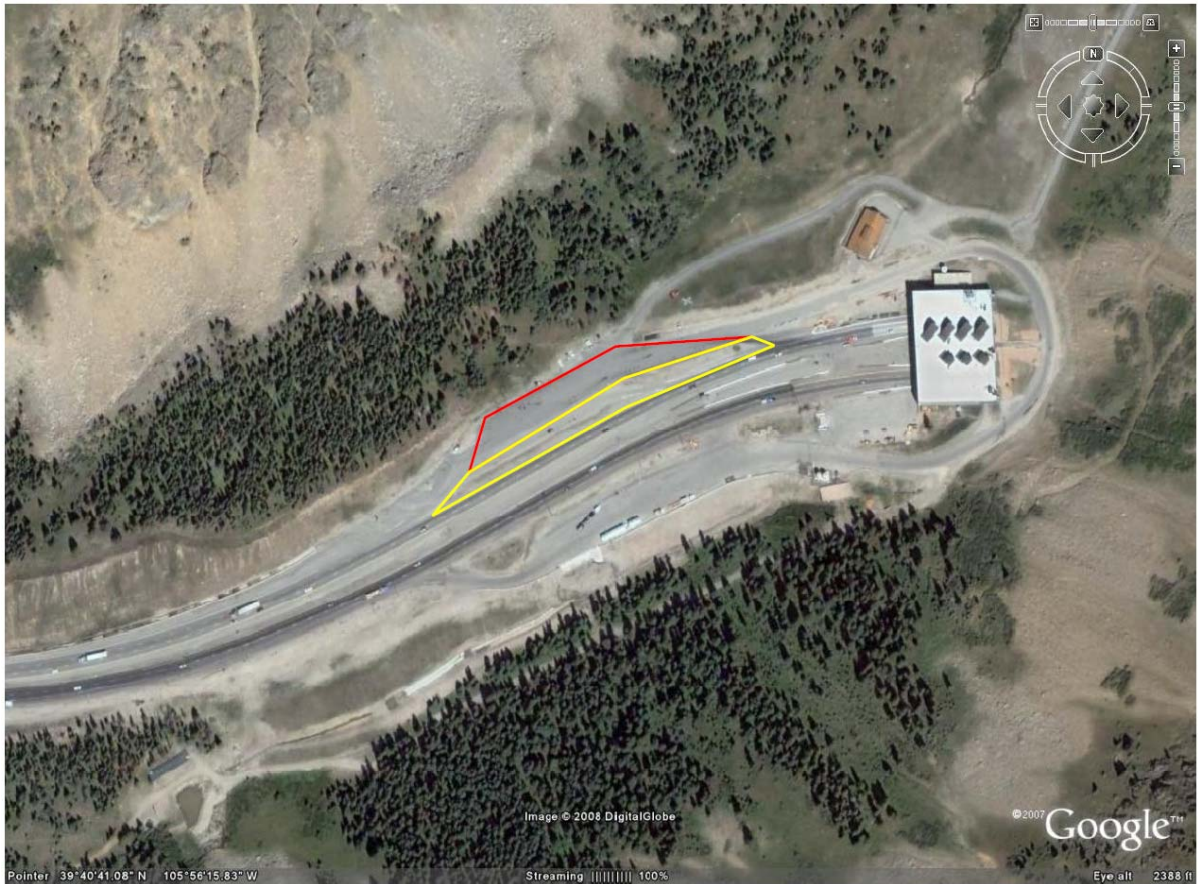

Separated from I-70	✓
Static Sign	Pending
Variable Speed Limit Sign	n/a
Lighting	High Mast I-70 Tunnel Lighting
Linkage Interference Zone	
# Spaces	6

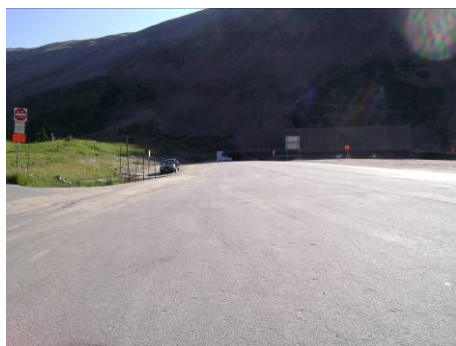

Westbound MP 219- Watrous Gulch



Directly Adjacent to I-70	✓
Static Sign	Pending
Variable Speed Limit Sign	Pending
Lighting	Pending
Linkage Interference Zone	✓
# Spaces	20





Westbound MP 221- West of Bakerville



Directly Adjacent to I-70	✓
Static Sign	✓
Variable Speed Limit Sign	Pending
Lighting	Pending
Linkage Interference Zone	✓
# Spaces	28



## Westbound MP 223- East of existing variable message sign



Directly Adjacent to I-70	✓
Static Sign	✓
Variable Speed Limit Sign	Future
Lighting	Future
Linkage Interference Zone	
# Spaces	8

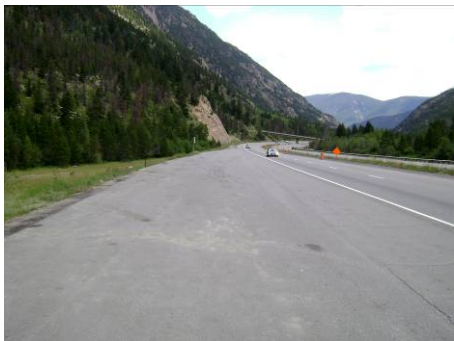

Westbound 228- Georgetown



Separated from I-70	✓
Static Sign	✓
Variable Speed Limit Sign	✓
Lighting	Pending
Linkage Interference Zone	
# Spaces	41



Westbound MP 254- Buffalo Overlook



Separated from I-70 with Guardrail	✓
Static Sign	✓
Variable Speed Limit Sign	✓
Lighting	Future
Linkage Interference Zone	✓
# Spaces	12



Westbound MP 260- C-470 Interchange



Directly Adjacent to I-70	✓
Static Sign	✓
Variable Speed Limit Sign	✓
Lighting	Interchange Lighting
Linkage Interference Zone	
# Spaces	7



Westbound MP 263- North of 20<sup>th</sup> Avenue



Directly Adjacent to I-70	✓
Static Sign	✓
Variable Speed Limit Sign	✓
Lighting	n/a
Linkage Interference Zone	
# Spaces	30



# Recommendations

---

The recommendation that resulted from the chain station workshops is that all chain stations and modified chain stations will include the following features:

- Physical separation from I-70
- Signing
- Single exit and entrance points
- Lighting that is used during storm events only
- ITS that can be activated during storm events

Chain stations will be constructed as shown in preferred chain station cross sections, Exhibit 23 or Exhibit 24. Environmental impacts will be given strong consideration when selecting a chain station cross sections and location. Environmental impacts should be minimized.

In the future, if a new chain station or a modified existing chain station cannot be physically separated from I-70 and the design needs to be varied from the cross sections shown in Exhibit 23 or Exhibit 24, CDOT will convene a chain station workshop so the design challenges and any proposed variances to the preferred chain stations cross sections can be discussed with the group. The group will discuss issues and concerns they may have with the proposed design modifications and work toward a design approach that has endorsement of the stakeholders.

CDOT views the chain stations as one important element in the overall truck mobility planning and in ensuring safe and effective mobility for the users of the I-70 Corridor. Other important elements include:

- Truck parking – currently being planned in Eagle County
- Courtesy patrol
- Chain assistance program (vendors)
- Heavy tow program
- Dynamic speed limits through the corridor – responses to conditions in the corridor

At this time, no additional funding is expected for work on the existing chain stations. Improvements to chain stations would likely be done when roadway improvements are made in the corridor.

## Proposed Typical Chain Station Separated From I-70 with One Driving Lane and One Parking Lane

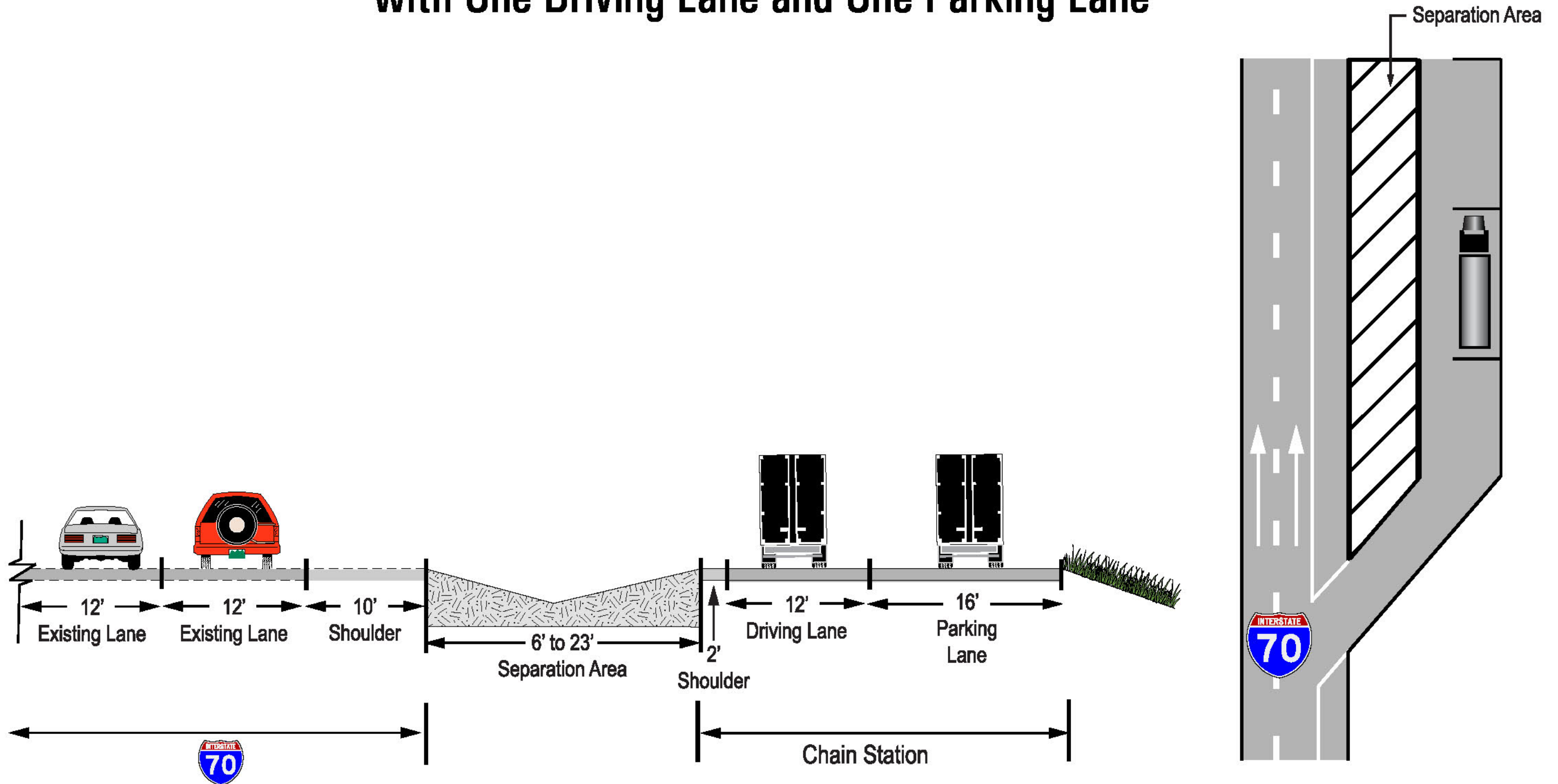
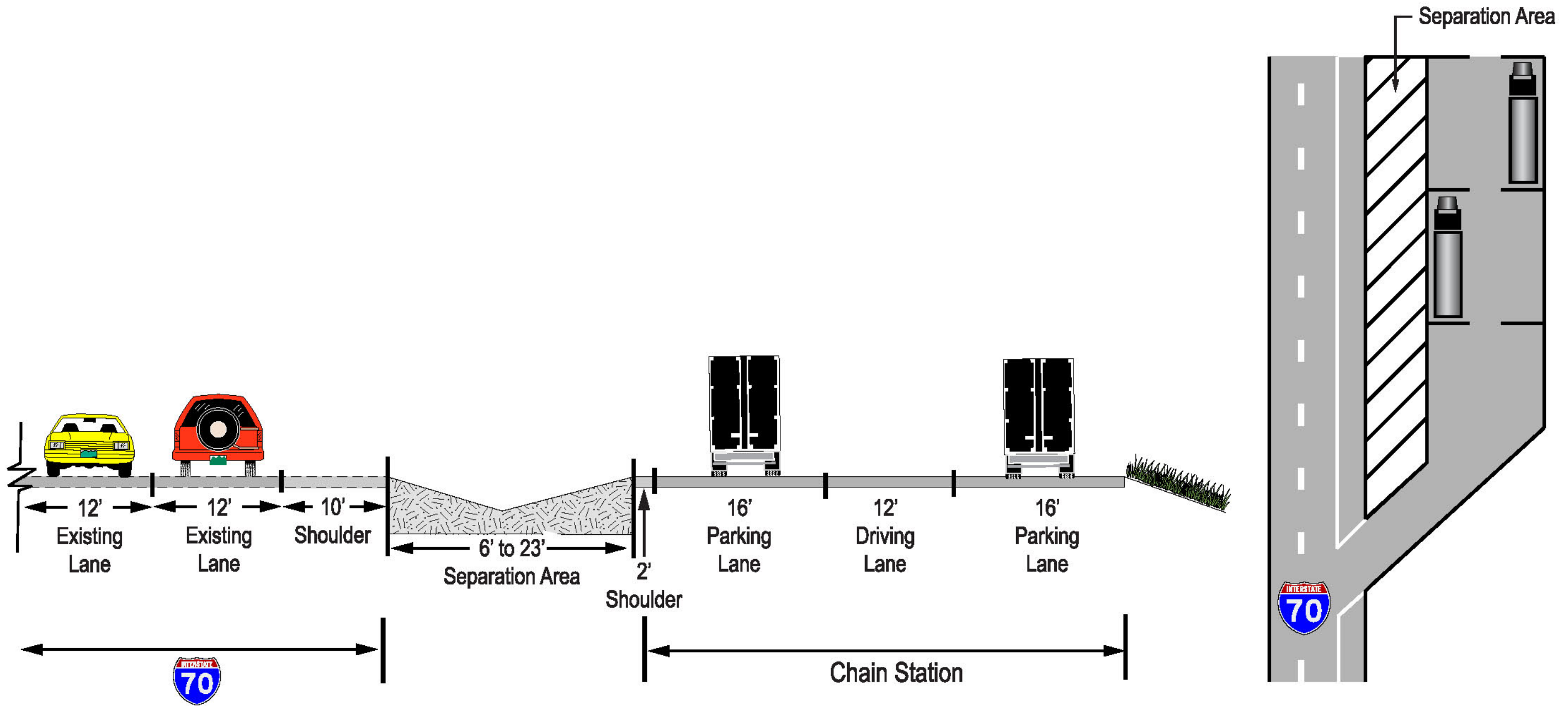

EXHIBIT 23



## Proposed Typical Chain Station Separated From I-70 with One Driving Lane and Two Parking Lanes





# Implementation

---

This plan will be used by all CDOT staff, planners, designers, and project managers that work in the I-70 Mountain Corridor. The plan provides guidance for planning, designing, and constructing I-70 Mountain Corridor chain stations.

At this time, no additional chain stations are planned to be constructed. If funding becomes available and additional locations for chain stations are identified, this plan will guide the design. This plan also provides guidance on how existing chain stations should be modified as they are impacted by the proposed I-70 Mountain Corridor PEIS.

This plan may have to be updated. Research continues on snow traction technologies that could replace chains. As conditions in the corridor and technologies change, CDOT may convene a chain station workshop to discuss the issues, challenges, and updates to this plan. CDOT will work with stakeholders to update this plan so that it can continue to be valid and provide guidance to the planning, design, and construction of chain stations.



# Appendix A

---



## Meeting Minutes

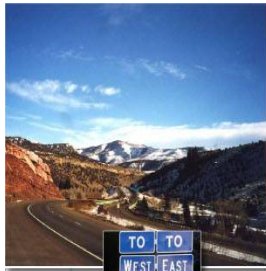

## **I-70 Context Sensitive Solutions**

# **I-70 Mountain Corridor Chain Station CSS Process Summary**

## Introduction and Background

The Colorado Legislature recently proposed and passed HB07-1229 Bill. This new law puts into effect stricter fines for truck drivers who do not use chains when the chain law is in effect. The goal of this legislation is to improve the operations during winter months of the major interstates within Colorado.

This law has implications for the I-70 Mountain Corridor. One particular impact for the I-70 Mountain Corridor is the need for more chain-up and chain-down stations and for improvements to the existing stations. The Colorado Department of Transportation Region 1 staff is responsible to plan, design and construct the needed chain station improvements.

When a truck has chains on the tires there must be snow pack on the road surface or damage to the chains and the roadway surface will result. This requires chain stations to be available in close proximity to locations where the chain law is most frequently put into effect. These locations are coincident with steep grades through the corridor, such as Floyd Hill, Georgetown Hill, Vail Pass, and the approach to tunnel.

Truckers, local Emergency Medical Providers, and local users are concerned about the safety of these chain stations. Further local residents and CDOT maintenance workers see the year round uses of these chain stations and are concerned about the safety for summer users, protecting the wildlife from closer access by tourists, and the use of these areas as rest stops.

To address the multi-faceted nature of these stations and arrive at a mutually acceptable design and phasing plan for these chain stations, a Context Sensitive Solutions approach was employed.

This approach began with the CSS Corridor Management Team studying the engineering elements of chain stations, understanding the current available funding, and planning a day long workshop bringing together the many concerned stakeholders.

The workshop was held on April 17, 2007 and the many interests were well represented. Attendees included representatives from the trucking industry, the local emergency medical response providers, the Colorado State Patrol, the Port of Entry, CDOT maintenance teams, the design team and the Region 1 leadership for the corridor. This agenda was used to conduct the workshop.

Attached to this summary are the comments, concerns, and ideas discussed during the workshop. The morning was spent discussing the best design elements that should ultimately be included in all of the chain station designs. The afternoon was a discussion of the best use of the current funding. The workshop wrapped

### Agenda

<b>9:00 a.m. – 9:30 a.m.</b>	<b>Welcome and Introductions</b>
<b>9:30 a.m. – 10:00 a.m.</b>	<b>CSS and Chain Station Project Overview</b>
<b>10:00 a.m. – 12:00 a.m.</b>	<b>Final Design Issues</b>
<b>12:00 p.m. – 1:00 p.m.</b>	<b>Lunch and Summarize</b>
<b>1:00 p.m. – 2:00 p.m.</b>	<b>Phasing the Construction</b>
<b>2:00 p.m. – 3:30 p.m.</b>	<b>Prioritize for Phasing</b>
<b>3:30 p.m. – 4:00 p.m.</b>	<b>Summarize and Wrap up</b>

up with a discussion of the engineering considerations used to prioritizing the construction package elements given the available funding.

## **Design Issues Summary**

The following issues and goals are a sampling of those expressed, discussed and agreed up by both small groups as the important design considerations.

**Safety** - All agreed this is the single most important issue. Separation between the travel lane and the parking area designated for chaining activities was seen as the safest design. Separation also provides for a single exit and entrance point for users of the chain station, this improves safety because those not stopping at the chain stations know where trucks will re-enter the traffic.

**Multi-use** - The mountain corridor is limited in locations that provide for pulling off the road, whether these are used for chain stations, disabled vehicles, enforcement activities, or scenic stops for travelers, these areas are limited. Therefore, designing specific chain stations for multi-use is agreed to be an important consideration.

**Environmental** - Noise, air pollution and water quality impacts are concerns and designs that lessen or eliminate these impacts should be employed.

**Lighting** - During snow storms when the chain law is in effect, lighting to aid the truckers in chaining their vehicles is important. However, this lighting should not be available at any other times. Lighting affects wildlife and residents, as well as increasing maintenance.

**Signing** - Intelligent Transportation Signing is considered the best options for the chain stations. ITS can be in effect only when needed, it will be more noticeable during snowing, and it can serve multiple purposes, such as lowering the speed limit and informing drivers of the proximity of chain stations.

**Enforcement** - Founded in years of observation, there is great concern about out-of-state truck drivers ignoring the chain law. The chain law, when in effect requires truckers to use chains, but further it requires chains are on board all trucks traversing the mountains.

**Education** - Again, based on years of observation, not all truck drivers are aware of the chain law and its requirements nor are they aware of the location of chain stations. Information provided in pamphlets and in interactive kiosks at truck stops can give drivers new to the Colorado mountains valuable information about the chain law requirements, real-time notice the chain law is in effect, locations of chain stations, and even locations to purchase chains if needed.

## **Priorities for Phasing Summary**

The following summarizes the group's discussion and agreement of what should be considered when determining the phasing of the chain stations.

**Safety** - Again, there was complete agreement that improving safety and building all new spaces in the safest and most cost effective way possible was the most important consideration when phasing the constructions.

Safety was felt to be best served with a combination of elements.

- **Signing** was also seen as a highest priority with the safety issues. Without signing directing truckers to the chain stations, many simply pull off the road to complete chaining activities.
- **Physical separation** between the travel lanes and the parking areas was considered the best safety improvement.
- **Reduction in speed limit** available with ITS signing was also considered a critical safety issue.
- **Additional spaces** were recognized as a critical need to improve safety.

**Build at fewer locations and do the chosen sites as models.** A great concern was expressed that doing many locations in a least cost approach would result in little or no improvements in the future. The citizens and local medical providers were concerned that once adequate parking spaces for chaining were available the pressure would be gone to add other elements like physical separation, ITS signing, wildlife friendly fencing and other multi-use elements.

It was also discussed that doing an excellent design now on a couple of sites would make future funding more easily available because it would show the quality of work CDOT does. A discussion of sites that should have the highest priority, lead to the direction those sites chosen should be those with the greatest need. Determining this need should be based on frequency of the chain law in a location, proximity to steep grades, locations with a current shortage of spaces and locations with an accident history.

**Lighting** was recognized as a critical element for the chain stations. Improved visibility for truckers while they are chaining will decrease the time it takes and make each parking space available sooner for the next trucker. However, it was also discussed that lighting should not be included in the current project because of the limited dollars available.

**Education** was also seen as a critical element in the safety of the corridor and enforcement of the chain law. Several ideas were discussed and it was agreed that the current construction dollars are best spent on construction in the corridor. Other avenues should be explored to increase the information and understanding of the mountain driving conditions. Several members of the group have considerable insight into means and methods to get the information in the hands of the truckers.

**Courtesy Service** was discussed and all agreed that a program that provides chains, tows, information and even help in chaining-up would directly improve the operations and safety of traveling in the corridor during inclement weather. The possibility was discussed of the Courtesy Service providing the snow plowing for the chain stations.

## **Workshop Wrap Up**

The conclusion of the workshop was a recap of the small group discussions. The group has several information requests of the project team, concerns about the environmental



clearance status of the upcoming construction and interest in staying informed on the next steps taken.

The following commitments were made to the group.

The Chain Station Design Team will provide:

- Accident data for the corridor

- Status of the clearances

- The decision matrix which will be used to prioritize the construction dollars

The CSS Team will:

- Discuss the possibility of more time to determine the priorities for construction

- Work with the Chain Station Design Team on the decision matrix

- Research additional dollars to complete more of the elements identified

- Get back to the community regarding the decisions made

### **Follow up Meetings**

Two meetings were held after the workshop to discuss the specifics of the design package being prepared. One meeting was held on April 20, 2007 and another meeting on April 24, 2007.

#### **April 20, 2007 Meeting**

The meeting held April 20, 2007 was intended to use the feedback from the April 17<sup>th</sup> Workshop and developed what should be included in the chain station design package.

The attendees at that meeting were:

- Scott Hoftiezer/CDOT Reg. 1 Traffic

- Bernie Guevara/CDOT

- Saeed Sobhi/CDOT

- Bill Scheuerman/CDOT

- Mary Jo Vobejda/CH2M HILL

- Dave Millar/PBS&J

- Flo Raitano/I-70 Coalition

- Cindy Neely/Georgetown

- Patty Olsgard/CMC (Colorado Motor Carriers)

- Joe Russel/Silverthorne Police

The group discussed and agreed that the following items were the critical goals/directions for CDOT to address:

- Make improvements in fewer locations or improve only one location(s). This is the approach preferred given CDOT's limited funding for chain station development. It is better to focus on a few locations rather than to spread the resources over several locations.
- Physical separation. Primarily for safety reasons, CDOT should strive for physical separation, not just separation by distance.
- Provide as many spaces as possible for truckers.
- Address wildlife issues.

The group identified the priorities stations for expanding and physically separation as:

- 219 EB Herman Gulch
- 229 WB & EB (connected to 219. If CDOT does a better job at 219 then 229 may not be an issue) Georgetown

The group agreed that 219 EB Herman Gulch is the best location for an expansion. This site should be the number one priority and completed as a "signature project".

Physical separation is possible at 219 EB. The site could be expanded to maximize the spaces.

The following item still needs to be completed at 219 EB:

- Agreement with Fish & Wildlife Service regarding the Biological Opinion. US Fish & Wildlife believes this is a critical lynx crossing, therefore, CDOT has proposed to mark 1% of the funds from every project for use to construct a crossing. This proposal has been reviewed by US Fish and Wildlife and it looks like this will lead to a quick Biological Opinion.
- Stipulate in the plans that CDOT will not build this site if no Biological Opinion is agreed upon.

Other high priorities discussed by the group include:

- Signing
- CDOT making a formal commitment to fund the ultimate vision for chain up areas in the I-70 mountain corridor.

### **Options for Design Package**

To prepare for the April 20<sup>th</sup> meeting, the design team prepared a matrix of costs for each station and 3 improvement options that seemed to be consistent with the direction of the April 17<sup>th</sup> workshop.

The design team has used the following elements in a decision matrix to consider and discuss the priorities for the current funding.

Some criteria had several elements and each criterion was weighted. See table below.

### Weighting of Criteria for the Decision Matrix

Criteria		Weight
Demand		5
Safety	Does it have a buffer or not?	5
	Site Distance	1
	Accel/Decel lanes	1
	Buffer Size	3
Sustainability		1
Crash Information		1
Cost		1

**The design team looked at the highest score and then cost effectiveness.** From this matrix 3 design options were developed. All options held EB 219 as the highest priority, it could be the model. The group assumes that 229 could also have some improvements completed. The following describes the improvements included at stations 229 WB, 229 EB, and 219 EB.

#### **Georgetown 229 WB:**

- Physical separation, lighting, signing
- Could have even more spaces with double line of spaces
- Needs a landscape solution

#### **Herman Gulch 219 EB chain down:**

- Physical separation, lighting, signing
- Meets the demand
- Has the wildlife issue & requires Fish & Wildlife Service to agree with the plan

#### **Georgetown 229 EB = chain down:**

- Lower priority if 219 EB is done this year

A forth improvement option, Option 4, was developed from the conversation and the attendees agreed that it would be consistent with what was heard at the April 17<sup>th</sup> workshop and was a good use of the \$2.37M.

**Option 4 included:**

Signing and communication at MP 177, MP 183, MP 184, MP187 and MP 195

Signing, communications, additional spaces at MP 203 & 205 EB

Construction of 12 new spaces with signing and communications at MP 219 EB

Construction of 8 new spaces with signing and communications at MP 221 WB

Signing and communication at MP 223 WB

Signing and communication at MP 228 EB \*

\*hope to eliminate the need for more spaces based on the improvements at MP 219 EB

Construction of 15\* new spaces with signing and communications at MP 228 WB

\* the 15 spaces was assumed based on the idea of widening further and creating two lanes

Signing and communication at MP 241 EB

Highlighting indicates these items were able to be included in the design package presented at the April 24, 2007 meeting.

## April 24, 2007 - FOR/FIR Meeting

### Discussion of the designs at specific locations included:

#### 219 EB:

- Physical separation of 30' clear zone
- ROW seems to be no problem

If CDOT improves 219 EB, it could take the demand away from 228 EB. This could mean no new construction would be needed at 228 EB. This could mean that CDOT would be able to push the EB pull-out further east, away from the entrance ramp

#### 228 EB Georgetown:

- May be less important with the improvements at 219 EB
- This location should be considered for a pull-out in the ultimate chain station vision (there is room)

#### 228 WB:

- This would be the "model" chain station for CDOT.
- A double - lane pull out should be constructed.
- A pull out with 30' clearance would work.
- ITS signing would be needed.
- These improvements result in only 20 spaces (this is only 1 more than currently exist)
- Courtesy Patrol should be seen as a way to increase capacity; this can be done when the chain law passes.
- **IDEA Developed by the Group!!** Locals might build split rail fences; may be able to eliminate "closure gate" if fencing was in place

CDOT needs to look for ways to get more spaces at 228 WB

**At the conclusion of the meeting the design team agreed to look at lengthening 228 to the east or widening more to increase the number of spaces.**

#### 241 EB:

- Located on the west side of the Twin Tunnels.
- Drainage is an issue in this area.
  - The group wants lighting.
- This chain station has merge & diverge issues.
- Can gain 11 spaces at this station.

- This is not a pull-out design.
- Could use a portable VMS at the point of entry to emphasize "USE THIS" chain up station.
- Includes ITS signing
- Idaho Springs can not issue permit while 1041 is under litigation!

**254 WB:**

- Buffalo overlook (widening will be done by another project).

**243 WB:**

- Not being done.

**251 EB:**

- Not being done.

**Wrap up on CSS discussions**

The CSS portion of the meeting was concluded with a comment period for the group.

The priorities of Tuesday, April 17th were used to create the work presented at the April 24, 2007 meeting; however, the ultimate vision could still need work. The design team will reconvene on Friday, April 27, 2007, to get the final design package for construction based on some of the feedback from the April 24, 2007 meeting.

**Summary of the Comments:**

- o Concern at Georgetown – Spending \$400, 000 for 1 space is not cost efficient. CDOT should find a way to add spaces at this location.
- o The CSS process that was used for the Chain up design process has been good. It is an improvement from the public process used to date on the corridor. One individual stated that they like talking directly to CDOT engineering & maintenance staff.
- o This has been a good process so far.
- o 219 EB needs to be done.
- o 228 EB needs to be separated.
- o Would like to see final design for 228 WB.
- o Good process.
- o It is important to move forward and make some of the chain up improvements.

- Provide information to the truckers before they get to mountains - VERY IMPORTANT!!
- Did we get accident information? Please include in recap.
- The process felt like collaboration.
- Providing information and education to the truckers is critical.
- The information strategy could use guidance.
- An individual appreciated the chance to bring up the wildlife issue.
- CSS process is working.
- Everyone is “seeing” the other person’s side.
- 228 WB design needs a little work.
- 241 is problematic.
- Keep groups engaged.
- Keep looking at new information to see if things are working.
- Think about having limitations 1<sup>st</sup> a better way to do the process
- Everyone needs time to look at things.
- Don’t anticipate Division of Wildlife will have issues that stop the show.
- An individual appreciated being included.
- Hope all will help secure money for multi-year funding.
- Georgetown; Herman Gulch; Floyd Hill are the highest priorities for the truckers.
- Capacity and safety are critical to being able to comply with the new law.
- Safety must remain our number 1 issue.
- This work is consistent with Colorado State Patrol goals to reduce fatalities.
- Need to partner to accomplish a reduction on fatalities.
- Safety is number 1 to CDOT maintenance staff
- No additional time is possible
- Working together has solved some of these needs
- Provide information on Twin Tunnel lighting
- An effort to monitor the actual operations on these stations should be started.

## **CSS SUMMARY**

The following summarizes the resulting design and construction activities:

### **Phase 1 - Scope comprises widening, asphalt, signs/communications.**

The project consists of work at 6 locations between MP 216 and 251. Signing and communications at 6 sites and asphalt work at 5 of these sites. A

separation buffer was included at WB 221/Bakerville, WB 228/Georgetown, EB 241/Twin Tunnels, and EB 251/El Rancho. No lighting is included with project.

Budget - \$2.47 Million

Schedule - Awarded to Asphalt Specialties. Completion in October '07. In conjunction with this project, added 4 other chain station sites that were done by on-going construction contracts (EB 205/Siverthorne, WB 254/Buffalo Herd Overlook, WB 260/C470 and WB 263/Denver West)

**Phase 1A - (supplemental Project) Scope comprises mainly signing and communications.**

The project consists of work at 7 locations between MP 177 and MP 254. Signing and communications provided at 7 locations. A separation buffer was included at EB 219/Herman Gulch. No asphalt work or lighting is included with project except for WB 219.

Budget - \$1.4 Million

Schedule - Awarded to Interface Communications. Completion of signs at critical locations this year with remainder completed summer '08.

**Phase II - Scope comprises mainly lighting the Phase 1 &1A sites**

The project consists of work at 17 locations. The majority of the work provides lighting at 16 of 17 locations with signing and communications at 4 of the locations. Asphalt work provided at 2 locations.

Budget - approximately \$4 Million

Schedule - Work anticipated to begin summer of '08 as funding becomes available

**Actions forward**

The results of this report will be distributed to those participating. Performance of the completed chain stations will be monitored throughout the upcoming winter season. Resulting adjustments/revisions in performance standards will be incorporated in future chain station installations accordingly



**ATTACHMENT A**  
**SUMMARY OF WORKSHOP ISSUES**

**G**  
**r**  
**O**  
**u**  
**p**  
  
**1**

<b>Chain Station Location</b>	<b>Issue</b>	<b>Goal Surrounding the Issue</b>	<b>Group Solution or Direction to the Designers</b>	<b>Notes</b>
Global	Who uses Chain Stations? <ul style="list-style-type: none"> <li>• Rental Agencies</li> <li>• Truckers</li> <li>• Personal Vehicles (not commercial)</li> <li>• Variety of truck types</li> <li>• Drivers from Colorado</li> <li>• Drivers from other states</li> </ul>	<ul style="list-style-type: none"> <li>• Education for all users</li> <li>• Clear Signage</li> <li>• Clear Messages regarding who is affected by the chain law, when and where</li> </ul>	<ul style="list-style-type: none"> <li>• Flyers at truck stops, POE</li> <li>• Media coverage</li> <li>• Locations (chain-up or chain-down and truck parking)</li> <li>• Use VMS</li> <li>• Key is consistency and education</li> </ul>	
Global	Air Pollution	<ul style="list-style-type: none"> <li>• Minimize impacts to wildlife and local communities</li> </ul>	<ul style="list-style-type: none"> <li>• Restrict idling time</li> <li>• Analyze impacts site-by-site</li> </ul>	
Global	Noise at chain stations	<ul style="list-style-type: none"> <li>• Minimize added noise at chain stations near residences.</li> <li>• Consider how is it impacted for/by long-range</li> </ul>	<ul style="list-style-type: none"> <li>• Don't preclude future noise walls</li> <li>• Put walls in now if warranted by noise studies</li> <li>• Determine appropriate factors to perform noise studies and when</li> </ul>	

Chain Station Location	Issue	Goal Surrounding the Issue	Group Solution or Direction to the Designers	Notes
		improvements	<ul style="list-style-type: none"> <li>• Minimize gearing up/down noise by placing of chain stations away from sensitive receptors</li> <li>•</li> </ul>	
Global	Restrooms	<ul style="list-style-type: none"> <li>• Install only at selected areas, not all.</li> <li>• Improve existing impacts to local communities</li> </ul>	<ul style="list-style-type: none"> <li>• Consider SST</li> <li>• Minimize maintenance challenges</li> <li>• No Temporary – make permanent</li> <li>• Minimize trash/wildlife impacts (sturdy containers, bear-proof, etc).</li> <li>• Aesthetics – fencing, color, general material considerations</li> </ul>	
Global	Multi-Use	<p>Chain stations get used during the summer for other uses, so plan for multi-use or sign for no use except when chain law is in effect.</p> <p>Carefully select the multi-use sites and then incorporate management controls for all of the various uses.</p>	<ul style="list-style-type: none"> <li>• Use wildlife friendly fencing</li> <li>• Minimize impacts (safety, wildlife, disruption, etc.)</li> <li>• Minimize parking duration (e.g. 30 minutes) where appropriate.</li> <li>• Allow for traffic stops, truck inspection, trucker rest areas.</li> <li>• Use option to close down if safety becomes an issue.</li> <li>• Redirect as appropriate to other areas (distribute usage).</li> <li>• Evaluate</li> </ul>	

Chain Station Location	Issue	Goal Surrounding the Issue	Group Solution or Direction to the Designers	Notes
			<p>management of other issues (noise, pollution, etc.).</p> <ul style="list-style-type: none"> <li>• Evaluate speed mitigation measures.</li> <li>• Consider speed differential between chained vehicles and those not chained.</li> </ul>	
Global	Lightings	<p>Use only when chain law in effect. Minimize impact to wildlife</p>	<ul style="list-style-type: none"> <li>• Use “Dark Skies” compatible lighting.</li> <li>• Use wildlife and community friendly lighting.</li> <li>• Highway versus parking needs for lighting brightness should be considered.</li> </ul>	
Global	ITS – This is a high priority	<ul style="list-style-type: none"> <li>• Lighting</li> <li>• Cameras</li> <li>• Messages</li> <li>• High Advisory Radio (HAR)</li> </ul>	<ul style="list-style-type: none"> <li>• Use where possible now, plan for ITS at all locations when fiber connection is available.</li> <li>• Install wireless kiosks at advance locations where truckers could check road conditions</li> <li>• Install wireless kiosks at trucker stops/POE’s to provide information for what type of vehicles, station locations, etc</li> </ul>	High Priority

Chain Station Location	Issue	Goal Surrounding the Issue	Group Solution or Direction to the Designers	Notes
			<ul style="list-style-type: none"> <li>• Activate signs and lights only when needed</li> <li>• Develop fail-safe system that works with or without power (e.g. outages or where fiber is not available).</li> </ul>	
Global	Need physical separation. Just widening with stripe/asphalt is not acceptable	Without separation is it a safety concern to truckers and traveling public. Striping does no good when snow is on the road.	<ul style="list-style-type: none"> <li>• Consider each site for the best option for separation</li> <li>• Where there is not room, don't build a chain station.</li> <li>• Vail Pass is a good example of how to build it right.</li> <li>• Guard rail is not preferred. Presents added hazard.</li> <li>• Consider low-profile delineation, e.g. change in grade/elevation, drainage swale, island</li> <li>• Consider that travel speeds are lower during inclement weather.</li> <li>• Don't use cable rail.</li> <li>• Consider traffic operations in proximity to interchanges and allow ample decel/accel.</li> <li>• Need to design to allow snow</li> </ul>	

Chain Station Location	Issue	Goal Surrounding the Issue	Group Solution or Direction to the Designers	Notes
			plowing. <ul style="list-style-type: none"> <li>• Consider courtesy patrols as a way to get chain stations plowed.</li> <li>• Evaluate speed mitigation measures, such as rumble strips for alert drivers to the chain station locations.</li> </ul>	
Global	Enforcement	Minimize road closures (full or partial)  Consistent enforcement	<ul style="list-style-type: none"> <li>• Increase awareness/funding for multi-jurisdictional enforcement (may require additional legislation)</li> <li>• Coordinate with Governor (Rep. Gibbs is already working on this) to determine various enforcement enhancements (e.g. more \$, staffing)</li> </ul>	
219 EB Herman Gulch	Multiple issues		<ul style="list-style-type: none"> <li>• Multi-use location</li> <li>• Provide lots of space</li> <li>• Provide separation</li> <li>• Improve advance signing (redirect from CS 217)</li> <li>• Lynx migration required</li> <li>• Minimize impacts to existing trails</li> <li>• Need Forest Service Permit for Chain up stations</li> </ul>	

Chain Station Location	Issue	Goal Surrounding the Issue	Group Solution or Direction to the Designers	Notes
			219, 221, 223, and 229	
221 WB Bakerville	Noise		<ul style="list-style-type: none"> <li>• Provide noise mitigation</li> </ul>	
228 EB Georgetown	<p>Traffic operations between trucks in and out of chain station and cars entering the highway from the ramp.</p> <p>Drifting snow</p> <p>Tourist cross-traffic</p>		<ul style="list-style-type: none"> <li>• Consider exiting at Georgetown ramp to access truck chain-up</li> <li>• Consider chain up on widened on-ramp</li> <li>• If ingress does not change provide physical separation</li> <li>• Provide fencing to deter cut-through traffic (tourists) between frontage road and ramp</li> <li>• Improve geometrics to reduce snow drifting</li> <li>• Use Dark Skies lighting</li> <li>• Requires Design Review Commission approval (could be part of 106)</li> </ul>	
228WB Georgetown	<p>Multi-use Lighting</p> <p>Wildlife</p>		<ul style="list-style-type: none"> <li>• Provide physical separation</li> <li>• Provide wildlife friendly fencing</li> <li>• Improve geometrics to reduce snow drifting</li> <li>• Use Dark Skies lighting</li> <li>• Requires Design Review</li> </ul>	

Chain Station Location	Issue	Goal Surrounding the Issue	Group Solution or Direction to the Designers	Notes
			Commission approval (could be part of 106) Similar issues (except for drifting) to 229 EB <ul style="list-style-type: none"> <li>• Key multi-use location</li> <li>• Manage Big Horn Sheep viewing area with signing and fencing</li> </ul>	
241 EB West of Twin Tunnels	Community Air/Water Impacts	Minimize	<ul style="list-style-type: none"> <li>• Design with the close proximity of the water discharge in mind</li> <li>• Study the use game check station road</li> </ul>	
243 WB	Sight Distance	Improve	<ul style="list-style-type: none"> <li>• Improve sight distance geometrics</li> <li>• Look at relocating within interchange area, on-ramps or cross road, consider operational/mixed-use impacts</li> <li>• Provide lighting</li> <li>• City of Black Hawk water intake - need to evaluate water quality impacts</li> <li>• Evaluate rock slide impacts</li> <li>• Look at alternative routing on US 6/40</li> </ul>	
254 WB Buffalo Herd Overlook 251 EB	Are these sites really of value?	Putting sites where they are needed and will be used.	<ul style="list-style-type: none"> <li>• May be lower priority due to infrequent need</li> <li>• May be</li> </ul>	No site specific issues at these

<b>Chain Station Location</b>	<b>Issue</b>	<b>Goal Surrounding the Issue</b>	<b>Group Solution or Direction to the Designers</b>	<b>Notes</b>
El Rancho			advantageous to relocate anyway due to distance to next chain station	locations



# Group 2

Chain Station Location	Issue	Goal Surrounding the Issue	Group Solution or Direction to the Designers	Notes (Not solutions or directions to designers)
Global	Signing		<ul style="list-style-type: none"> <li>• CDOT should obtain input into the signage from the Colorado State Patrol (CSP)</li> <li>• CDOT should empower the maintenance people who are out clearing the roads to make the call to <b>turn on the chain law into effect</b></li> </ul>	
Global	Striping		<ul style="list-style-type: none"> <li>• Do striping well in advance of the stations</li> </ul>	
Global	ITS Application		<ul style="list-style-type: none"> <li>• Address this together with signing</li> <li>• When the chain law is in effect, reduce the speed limit on the roads. Tie these two together</li> <li>• Do portable VMS if necessary, such as is done on Vail pass</li> <li>• Provide the necessary</li> </ul>	

# Group 2

Chain Station Location	Issue	Goal Surrounding the Issue	Group Solution or Direction to the Designers	Notes (Not solutions or directions to designers)
			<p>information to manage the sites</p> <ul style="list-style-type: none"> <li>Require truckers to have chains with their trucks as a standard safety device. Implement with legislation and enforce with CSP and Ports</li> <li>Make sure all signage, lights, and ITS applications are synchronized and working together</li> </ul>	
Global	Lighting		<ul style="list-style-type: none"> <li>Don't do downcast lighting at chain sites. Don't do the standard CDOT 30 foot lights. Very hard to see tires for chaining.</li> <li>Install side lighting to aid truckers with chaining</li> <li>Light both sides of the chain station</li> <li>Have station</li> </ul>	

# Group 2

Chain Station Location	Issue	Goal Surrounding the Issue	Group Solution or Direction to the Designers	Notes (Not solutions or directions to designers)
			<p>lights on when ever chain law is in effect - day or night</p> <ul style="list-style-type: none"> <li>• Use LED lights</li> <li>• Address lighting at multi use stations differently, based on individual site needs</li> </ul>	
Global	Multi-Use		<ul style="list-style-type: none"> <li>• There is a need for multi use areas in the corridor. Look for opportunities for these. Some places are not feasible for multi use</li> <li>• Herman Gulch is a good site for multi use</li> <li>• Need parking off the highway and need restrooms</li> <li>• Sign all applications at a multi use site</li> <li>• Design it, sign it, size it,</li> <li>• Consider topography of</li> </ul>	

# Group 2

Chain Station Location	Issue	Goal Surrounding the Issue	Group Solution or Direction to the Designers	Notes (Not solutions or directions to designers)
			<p>land and do a safe layout</p> <ul style="list-style-type: none"> <li>• Delineation between the road and station is critical</li> <li>• Be strategic. Consider construction, runoff, wildlife crossings. Keep people at stations from running up hill sides with dogs due to impacts to wildlife</li> </ul>	
Global	Restrooms		<ul style="list-style-type: none"> <li>• These are a good thing to have</li> <li>• Look for opportunities at multi use stations</li> <li>• Can strategically locate along the corridor. Don't need these at every station.</li> <li>• Make attractive</li> <li>• Separate restroom use area from chain station to reduce conflicts</li> <li>• Have trash</li> </ul>	

# Group 2

Chain Station Location	Issue	Goal Surrounding the Issue	Group Solution or Direction to the Designers	Notes (Not solutions or directions to designers)
			cans at each station	
Global	Aesthetics		<ul style="list-style-type: none"> <li>• Blend into the environment. This will be different at each location. Look at the surrounding area and have it fit in</li> <li>• Don't want a parking lot for trucks</li> <li>• Do screening of the stations</li> <li>• Do physical separation from the highway</li> <li>• Signing is important that it doesn't obstruct views</li> <li>• Do aesthetic treatments at every site</li> </ul>	
Global	Noise		<ul style="list-style-type: none"> <li>• Residents of Vail don't like the noise but don't want noise walls</li> <li>• Address site specific</li> <li>• Wind, visual, noise break – can have 3 issues addressed with one treatment.</li> <li>• Always</li> </ul>	

# Group 2

Chain Station Location	Issue	Goal Surrounding the Issue	Group Solution or Direction to the Designers	Notes (Not solutions or directions to designers)
			<p>consider when there are receptors in the vicinity of the station</p>	
Global	Delineation		<ul style="list-style-type: none"> <li>• Provide fully separated stations when physically possible - not just put up a Jersey barrier or other type of barrier. Take facility off the mainline.</li> <li>• Downhill grad approaching station is a real problem with safety. Need a full separation due to slick roads</li> <li>• Prioritize sites that can be separated.</li> <li>• Provide advance lighting and good stripping</li> <li>• The CSP says that full separation should be the end goal of all stations. This is the safest situation</li> <li>• Distance from</li> </ul>	

# Group 2

Chain Station Location	Issue	Goal Surrounding the Issue	Group Solution or Direction to the Designers	Notes (Not solutions or directions to designers)
			<p>traffic should be greater than 15 ft, according to the CMC representative . This is the “reasonable” clear zone.</p> <ul style="list-style-type: none"> <li>• Physical barrier is the only way to ensure safety</li> <li>• Provide barriers that would guide trucks and force them to accelerate before going into traffic. Barriers can direct them.</li> <li>• Chain up and chain down stations have different issues to be addressed</li> <li>• Mitigate issues by reducing the number of stations in the corridor – balance with need for stations that keep trucks from driving on dry roads</li> <li>• Prioritize input from</li> </ul>	

# Group 2

Chain Station Location	Issue	Goal Surrounding the Issue	Group Solution or Direction to the Designers	Notes (Not solutions or directions to designers)
			<p>emergency personnel in the corridor. They know the issues</p> <ul style="list-style-type: none"> <li>• Don't put stations near exits. Ports have problems with people driving into the port thinking it is the exit. Then, speed through the facility once they recognize their mistake. Creates a dangerous situation.</li> </ul>	
Global	Emissions		<ul style="list-style-type: none"> <li>• Address this location by location depending on receptors</li> </ul>	
Global	Water Quality		<ul style="list-style-type: none"> <li>• Address this location by location</li> </ul>	
Global	Safety		<ul style="list-style-type: none"> <li>• 15 or 30 feet space from traffic doesn't protect truckers because of the potential to slide during bad weather. Need a barrier</li> <li>• Maybe install barriers just</li> </ul>	



# Group

## 2

Chain Station Location	Issue	Goal Surrounding the Issue	Group Solution or Direction to the Designers	Notes (Not solutions or directions to designers)
			during the winter <ul style="list-style-type: none"> <li>• Operation with Respect to Maintenance</li> <li>• Evaluate merges in and out of stations to make safe</li> <li>• Don't impede snow removal vehicles</li> <li>• Don't add anything that will shade the road because of ice</li> </ul>	
Global	Grades		Find the flattest areas possible	
177 EB Vail	<ul style="list-style-type: none"> <li>• There is no WB chain down station for the Vail area. Consider this in the future (west of Vail Pass).</li> <li>• Management of the Station</li> </ul>		<ul style="list-style-type: none"> <li>• Work with Eagle County for parking</li> <li>• Do permanent signing, not a temporary portable VMS sign</li> <li>• Nothing for WB at this location so look across from EB 177 as a possible WB site</li> </ul>	<ul style="list-style-type: none"> <li>• Vail</li> <li>• Shown on map as (179-180)</li> <li>• Good location for a chain station</li> </ul>
187 EB Vail			No site specific issues at these location	
197 WB Copper Mountain			No site specific issues at these location	

# Group 2

Chain Station Location	Issue	Goal Surrounding the Issue	Group Solution or Direction to the Designers	Notes (Not solutions or directions to designers)
197 EB Copper Mountain			No site specific issues at these location	
203 EB Frisco Scenic Area	<ul style="list-style-type: none"> <li>This is a multi-use area.</li> <li>Some commercial drivers may think they can sleep here if it is labeled as a multiple use chain station</li> </ul>		<ul style="list-style-type: none"> <li>Be sensitive to the aesthetics of signs to operate this site, be careful not to block views</li> <li>Sign and operate as a chain-up area only. Make it a single use instead of a multi use site.</li> <li>Sign could be located on the nearby bridge so that views are not blocked</li> <li>Direct truckers to Eagle Co Fairgrounds for longer term parking</li> </ul>	<ul style="list-style-type: none"> <li>Plans show an expansion of 19 spaces.</li> <li>203 EB is an existing overlook</li> <li>Plans show a reconfiguration of what is there</li> <li>Today, this is a multi-use application</li> <li>Planned as a 30 minute chain station</li> </ul>
205 EB Silverthorne Dillon	<ul style="list-style-type: none"> <li>Merge is an issue. Traffic is merging onto I-70 while trucks are pulling over to the right to go to the chain up station.</li> </ul>		<ul style="list-style-type: none"> <li>Provide warning signs to travelers that reduced speed limit signs are ahead</li> <li>Sign well in advance to let people know the chain station is there</li> <li>Provide warning signs</li> </ul>	<ul style="list-style-type: none"> <li>205 EB is an existing station</li> <li>Planned improvements are signing and striping</li> </ul>

# Group 2

Chain Station Location	Issue	Goal Surrounding the Issue	Group Solution or Direction to the Designers	Notes (Not solutions or directions to designers)
			<p>on ramp (both sides) when chain law is in effect - "Use Extreme Caution - Truck Chain-up Site Ahead"</p> <ul style="list-style-type: none"> <li>• Ramp metering - consider this to see if it could improve operations</li> <li>• Move station further east to lessen the merge issue</li> </ul>	
217 WB West of EJMT Tunnel	<ul style="list-style-type: none"> <li>• An existing dirt pull-out. This is not an official site. CDOT needs to address whether this is a legitimate site or not, then approve as needed.</li> </ul>		<ul style="list-style-type: none"> <li>• Sign this area</li> <li>• A barrier is needed</li> </ul>	
219 EB Herman Gulch	<ul style="list-style-type: none"> <li>• Environmental issues at this location. Water quality, wildlife considerations.</li> <li>• Need Forest Service Permit to do this station.</li> </ul>		<ul style="list-style-type: none"> <li>• This site needs both outside and inside delineation.</li> <li>• 219 EB is a priority location for Clear Creek County. It is a "perfect" location. Easy to get away from the highway.</li> </ul>	<ul style="list-style-type: none"> <li>• This is a Chain down station</li> <li>• Herman Gulch is where the Continental Divide Trail starts</li> </ul>

# Group 2

Chain Station Location	Issue	Goal Surrounding the Issue	Group Solution or Direction to the Designers	Notes (Not solutions or directions to designers)
			<p>This is where a physical separation should be implemented. This does not mean separation with a barrier.</p> <ul style="list-style-type: none"> <li>• Put a sign right outside of the tunnel so that truckers will see it and know that there is a chain station ahead.</li> <li>• Work with Michelle Li to get the permit from the Forest Service.</li> <li>• This site is a good multi-use opportunity and a priority location</li> </ul>	
219 WB Herman Gulch	<ul style="list-style-type: none"> <li>• Potential environmental issues at this location such as wildlife conflicts</li> <li>• Parking area is there now. Existing Forest Service parking lot</li> <li>• What is currently designed by</li> </ul>		<ul style="list-style-type: none"> <li>• Do multi-use at this location</li> <li>• Do separation</li> <li>• Use already disturbed ground</li> <li>• Use the existing Forest Service Parking lot as a chain up area</li> </ul>	<ul style="list-style-type: none"> <li>• CDOW is currently tracking animals to obtain wildlife information but don't have data on hand</li> </ul>

# Group 2

Chain Station Location	Issue	Goal Surrounding the Issue	Group Solution or Direction to the Designers	Notes (Not solutions or directions to designers)
	CDOT is not acceptable		<ul style="list-style-type: none"> <li>This is a priority location</li> <li>This site needs both outside and inside delineation</li> </ul>	
221 WB Bakerville	<ul style="list-style-type: none"> <li>Chain stations 217, 219 &amp; 221 are very close, which make it tough to adequately sign each</li> <li>Noise impacts to "receptors"</li> <li>Potential water quality issues</li> </ul>		<ul style="list-style-type: none"> <li>Keep all three stations but provide one sign for all three</li> <li>Noise barrier in the area is appropriate</li> <li>Address potential water quality issues</li> </ul>	<ul style="list-style-type: none"> <li>Planned for expansion 5-8 spaces</li> <li>The Colorado Motor Carrier Assoc. representative stated that all of these stations meet the needs for various types of trucks</li> </ul>
223 WB East of VMS Sign	<ul style="list-style-type: none"> <li>Noise impacts to receptors</li> <li>Potential water quality issues</li> </ul>		<ul style="list-style-type: none"> <li>Noise barrier in the area is appropriate</li> <li>Address potential water quality issues</li> </ul>	
228 EB Georgetown	<ul style="list-style-type: none"> <li>Merge problem. Truckers can pull out at any point because there is no access control at the site</li> <li>Double merge issue</li> <li>How do we sign this?</li> </ul>		<ul style="list-style-type: none"> <li>Provide improvements that physically direct trucks to take exit ramp, go through the stop sign, and then up the entrance ramp to the chain station</li> </ul>	<ul style="list-style-type: none"> <li>This is where trucker fatality occurred</li> </ul>

# Group 2

Chain Station Location	Issue	Goal Surrounding the Issue	Group Solution or Direction to the Designers	Notes (Not solutions or directions to designers)
	<ul style="list-style-type: none"> <li>• Issues are similar to those listed in 228 WB</li> <li>• Wildlife habitat area</li> </ul>		<ul style="list-style-type: none"> <li>• Go up entrance ramp</li> <li>• Consider that stop sign</li> <li>• May need another lane for the trucks</li> <li>• Outside edge, need careful delineation</li> <li>• Need less of an acceleration lane</li> <li>• Not a multi-use site</li> <li>• Might want a windbreak in the area due to high winds</li> </ul>	
228 WB Georgetown	<ul style="list-style-type: none"> <li>• Merge problem</li> <li>• No access and egress delineated for trucks.</li> <li>• Bighorn sheep area, people stop to view the sheep</li> <li>• Multi-use issue is huge</li> <li>• Aesthetics - lights</li> <li>• Restroom sanitation</li> </ul>		<ul style="list-style-type: none"> <li>• Restrooms are needed at this site</li> <li>• 228 EB is a priority for safety</li> <li>• 228 WB is a high priority station for Clear Creek County</li> <li>• Physically separate this site from the highway. Do not separate with a guard rail or any other type of barrier. Grade separation is ok.</li> </ul>	<ul style="list-style-type: none"> <li>• Site located at Georgetown</li> <li>• This is the most popular chain-up area</li> <li>• Some fencing</li> <li>• Sheep want salt on road</li> </ul>

# Group 2

Chain Station Location	Issue	Goal Surrounding the Issue	Group Solution or Direction to the Designers	Notes (Not solutions or directions to designers)
			<ul style="list-style-type: none"> <li>Address multi-use issues at this site such as safety, signing of all applications and functions.</li> </ul>	
241 EB West of Twin Tunnel	<ul style="list-style-type: none"> <li>Merge issue</li> <li>Water quality - sewer plant close for Idaho springs</li> <li>Dust issue with potential water quality issues</li> </ul>		<ul style="list-style-type: none"> <li>Address merge issue</li> <li>Address water quality issues</li> </ul>	<ul style="list-style-type: none"> <li>This is planned as a new site with 11 new spaces</li> </ul>
243 WB Hidden Valley	<ul style="list-style-type: none"> <li>Merge Issue</li> <li>Dangerous area - truck accidents problematic</li> <li>Potential water quality issue</li> </ul>		<ul style="list-style-type: none"> <li>Make merge work</li> <li>Look at sight distance to see if that is a problem</li> </ul>	<ul style="list-style-type: none"> <li>243 WB planned for 4 new spaces</li> </ul>
251 EB El Rancho	<ul style="list-style-type: none"> <li>Merge Issue</li> </ul>		<ul style="list-style-type: none"> <li>Address the merge issues</li> </ul>	<ul style="list-style-type: none"> <li>El Rancho site</li> <li>6 new spaces are planned</li> </ul>
254 WB Buffalo Herd Overlook			No site specific issues at these location	

## ATTACHMENT B

### CHAIN STATION CSS PROCESS SUMMARY

#### APRIL 17<sup>TH</sup> WORKSHOP

- #1 priority Safety – Signing/Separation/ITS - incl speed reduction
- Other Important Design Issues
  - Lighting
  - Public/Trucker Education
  - Courtesy Service
  - Landscaping
  - Wildlife signing
  - Snow removal
  - Sanitary facilities
  - Aesthetics
  - Noise

#### April 20<sup>th</sup> FOLLOW UP MEETING

- #1 priority – 219 EB (Herman Gulch), Separation/Lighting/Signing
- #2 priority – 228 WB, Separation/Expansion
  - WB – add separation, lighting, signing, spaces, landscape;
  - EB – same as WB improvements except no added spaces;
  - 228 EB may not be as critical if 219EB is built accordingly.
- Other Important Design Issues
  - Improve fewer locations, but do better job per Clear Creek County.
  - Separation (where can be accommodated) is ideal for improved safety.
  - Provide as many spaces as possible per CMCA.
  - Signing and changeable reduced posted speed limit.
- Other Options
  - MP 177, 183, 184, 187, 195  
Add signing/communications
  - MP 203, 205 EB  
Add signing/communications/additional spaces
  - MP 219 EB  
Add signing/communications/12 additional spaces
  - MP 221 WB  
Add signing/communications/8 additional spaces
  - MP 223 WB



- Add signing/communications
- MP 228 EB
  - Add signing/communications
- MP 228 WB
  - Signing/communications/15 additional spaces
- MP 241 EB
  - Signing/communications/ 11 additional spaces.

**April 24th FIR/FOR mtg**

- 219 EB
  - Look to accommodate 30 ft separation
- 228 EB
  - Consider as pull-out in ultimate chain station vision
  - If CDOT improves 219 EB, demand would be taken away from 228 EB. CDOT instead could look to push the EB pull-out further east, away from the ramp entrance.
- 228 WB
  - Look at double lane entrance
  - Look to accommodate 30 ft separation
  - Add ITS signing
  - Look at lengthening or widening to the east to add more spaces
  - Locals might build split rail fences; may be able to eliminate “closure gate” if fencing was in place
- 241 EB
  - Look at improving drainage
  - Add lighting
  - Improve merge/diverge geometry
  - Add 11 spaces
  - Look at usage of portable VMS to emphasize “USE THIS” chain up station

# ATTACHMENT C

## I-70 MOUNTAIN CORRIDOR CHAIN STATION IMPROVEMENTS EASTBOUND

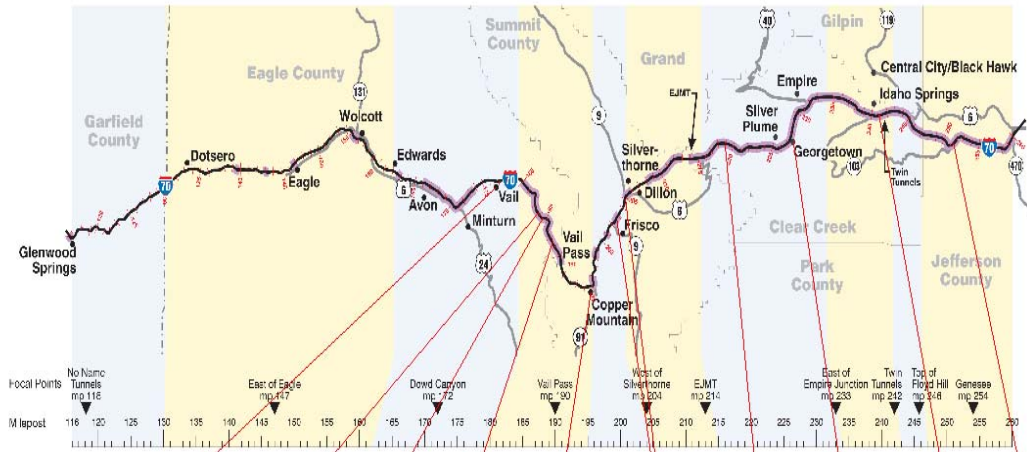

EB CHAIN STATIONS	MP 177 EB - APPROACHING VAIL	MP 183 EB	MP 184 EB	MP 187 EB	MP 195 EB -	MP 203 & 205 EB - DILLON AND SILVERTHORNE	MP 219 EB - HERMAN GULCH	MP 228 EB - GEORGETOWN	MP 241 EB - WEST SIDE OF TWIN TUNNEL	MP 251 EB - EL RANCHO
SPACES ADDED										
SIGNING/MESSAGE SIGNS ADDED										
LIGHTING ADDED										
Existing Spaces	37	11	15	19	5	30	0	16	0	0
New/Additional spaces	0	0	0	0	0	19	16	0	11	6
Total spaces	37	11	15	19	5	49	16	16	11	6

= Construction this year (07)
  = Construction next Year (08)

# ATTACHMENT D

## I-70 MOUNTAIN CORRIDOR CHAIN STATION IMPROVEMENTS WESTBOUND

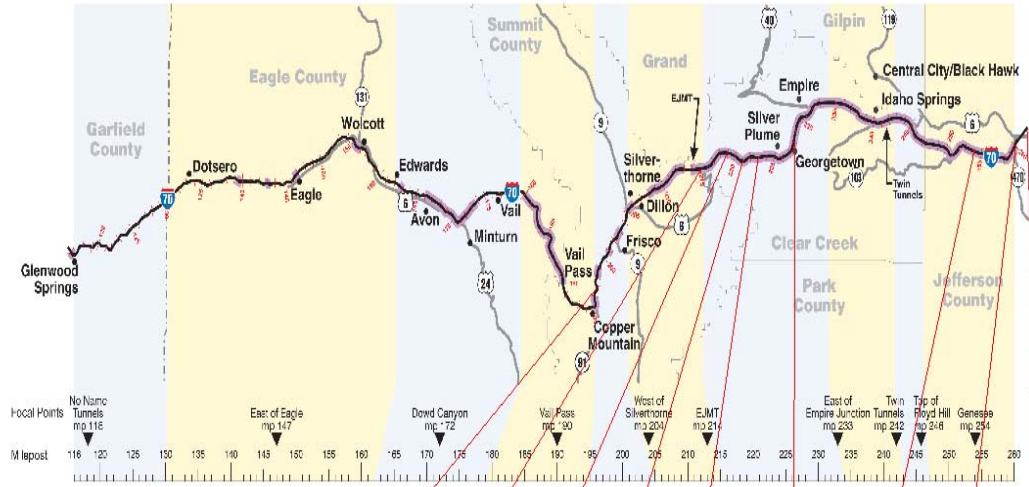

WB CHAIN STATIONS	MP 197 WB - NEAR COPPER MTN	MP 215 WB - WEST OF E.J.M.T	MP 219 WB	MP 221 WB - WEST OF BAKERVILLE INTERCH	MP 223 WB - EAST OF EXISTING VMS SIGN	MP 228 WB - GEORGETOWN	MP 254 WB - BUFFALO OVERLOOK	MP 280 WB AT C-470	MP 283 WB - DENVER WEST
SPACES ADDED									
SIGNING/MESSAGE SIGNS ADDED									
LIGHTING ADDED									
Existing Spaces	5	0	20	20	8	19	0	0	0
New/Additional spaces	0	8	0	8	0	22	12	7	30
Total spaces	5	8	20	28	8	41	12	7	30

= Construction this year (17)
  = Construction next Year (18)



# I-70 Context Sensitive Solutions

April 17, 2007

Facilitator's Agenda

**9:00 a.m. – 9:30 a.m. Welcome and Introductions**

Call to order	MJ	2m
Welcome from CDOT	Bill	3m
Introductions around the room	Bill	15m
Introductions of Cindy and Flo as members of the CSS PMT	Bill	5m
How this meeting came to be	Cindy/Flo	5m

**9:30 a.m. – 10:00 a.m. CSS and Chain Station Project Overview**

Presentation on CSS and today's goals	Bill	5m
Presentation on P&N, what's been done to date	MJ	5m
Introduction of Bernie and the Chain station project	Bill	5m
Presentation on Chain station project drivers, budget, schedule	Bernie	10m
Presentation on today's agenda and input opportunities	MJ	5m

**10:00 a.m. – 12:00 a.m. Final Design Issues Small Groups**

Group 1 (Group Leads -- MJ, Dave, Bill, Cindy)

In small groups go through the chain stations and discuss specific issues. Work toward direction for the designers for each issue. Record issue, goal in addressing issue, agreed upon solution, or next steps.

Group 2 (Group Leads -- Pat, Andrea, Kevin, Flo)

In small groups go through the chain stations and discuss specific issues. Work toward direction for the designers for each issue. Record issue, goal in addressing issue, agreed upon solution, or next steps.

**12:00 p.m. – 1:00 p.m. Lunch and Summarize Large Group**

This will be a working lunch depending on how well we get through the regional and corridor issues.

**1:00 p.m. – 2:30 p.m. Priorities of Phasing Small Groups**

Back in small groups to discuss site by site priorities.

"What would you like CDOT to consider when prioritizing sites for immediate construction?"

"What are elements that are of the highest priority?"

**2:30 p.m. – 3:30 p.m. Phasing the Construction Large Group**

Presentation on decision matrix and criteria for prioritizing and phasing of the sites and site elements for this first package of construction.

**3:30 p.m. – 4:00 p.m. Summarize and Wrap up Large Group**

Summarize the small group priority decisions

Schedule for the final design

Next steps (the FOR meeting on April 24<sup>th</sup>.)

MEETING ROSTER

DATE April 17, 2007

SUBJECT I-70 West Truck Chain Station Stakeholder's Meeting

	Name	Organization	Telephone	E-Mail Address
1.	RICK ARCHER	FORDS OF EN 724	303 206-5681	RARCHER@SPIKE.DOR.STATE.CO.US
2.	JO ANN SORENSEN	Clear Creek Cty	303-679-2409	jsorensen@co.clear-creek.co.us
3.	Dennis Lumberg	Edith Springs	303-567-4421	Major@edithsprings.co.co
4.	CYNTHIA NEELY	Town of George	303-569-0284	ceneely@vahoo.com
5.	DUANE CLEERE	PBS JT	303-221-7275	djcleere@pbsj.com
6.	MIKE SALAMAN	CPO T	303-573-5701	MICHAEL.SALAMAN@DOT.CO.US
7.	Fred Rotundo	I-70 center	970-393-2394	frsrtas@earthlink.net
8.	Ty Petersburg	Div. of Wildlife	303-916-1180	ty.petersburg@state.co.us
9.	John Calhoun	Silver Plume	303/569-2754	cmc-jtc@midsping.com
10.	Donna Mickley	USFS Clear Creek RD	303-567-3018	dmickley@fs.fed.us

MEETING ROSTER

DATE April 17, 2007

SUBJECT I-70 West Truck Chain Station Stakeholder's Meeting

	Name	Organization	Telephone	E-Mail Address
11.	CAD SALLI	Town Of Vail	970/479-2169	csalli@vailgov.com
12.	Patti Hestekin	CRENSHAW TRAIL BROWN UNIVERSITY AREA	303 561 2604	CHRIS365@earthlink.net
13.	Craig Abrahamson	CCEMS	303 567 4221	craig@clearcreekems.com
14.	Patti Olsford	CNUCA	3433-3375	patti@cnuca.com
15.	Melinda Urban	FHWA	720-963-3015	melinda.urband@fhwa.dot.gov
16.	Robert Appel	Robandy Express	303-340-2372	Bob Appel@Robandy-Com
17.	KELLY BASEDN	CLEAR CREEK FIRE AUTH.	303-994-7806	Kb@clearcreekfire.com
18.	JEFF ANDERSON	POFF OF EAM	303 567 4180	JAANDERSON@SPRUE.DOT.CO
19.	Harvey Dale	CCC	303-915-7962	hjd173@wisportel.net
20.	Bob French	Summit	970-453-3411	boof@co.summit.co.us

MEETING ROSTER

DATE April 17, 2007

SUBJECT I-70 West Truck Chain Station Stakeholder's Meeting

	Name	Organization	Telephone	E-Mail Address
21.	Michael Penney	1-70 coalition Town of Arapaho	970-665-9823	michaelpenney@townofarapaho.com
22.	Kenneth O'Malley	CRSAR CAREER	303-699-2312	KOMAL102@MSO.CO
23.	Michelle Li	COOT	3-965-7041	michelle.li@dot.state.co.us
24.	VICKY GIBBS	COLOWAY	303-567-4991	vicky@evergreen.co
25.	JD WILLIAMS	CSP	303-273-1943	JDEWEY.WILLIAMS@CSP.STATE.CO.US
26.	GARY TALBOTSON	CSP	303-273-1875	gary.talbotson@colorado.state.co.us
27.	Sherri Humer	CDOW	970 472 4466	Sherri.Humer@state.co.us
28.	Brian Pinkerton	CDOT R-1	303-325-7210	BRIAN, L. PINKERTON @dot.state.co.us
29.	Mary Jane Loerlich	IdahoSpin	303 867-4108	MJLoerlich@aol.com
30.	Joan Drury	Clear Creek County	303-674-2312 303-567-2673	JoanDrury@ccommiss@ccco.co

DATE April 17, 2007

MEETING ROSTER

SUBJECT I-70 West Truck Chain Station Stakeholder's Meeting

	Name	Organization	Telephone	E-Mail Address
31.	JOE RUSSELL	SILVERTHORPE POLICE	(970) 262-7326	jrusse11@silvertthorpe.org
32.	BOB WILSON	CDOT	3/757-9431	bob.j.wilson@dot.state.co.us
33.	Chuck STEARNS	Town of Georgetown	303-569-2555 x 3	gtownAdmin@earthlink.net
34.	Janet Gerak	CDOT	3/365-7043	janet.gerak@dot.state.co.us
35.	Allen Brown	PBSTJ	3-221-7075	arbrown@pbsj.com
36.	Saeed Sobhi	CDOT	3-365-7340	Saeed.Sobhi@dot.state.co.us
37.	Ken Wised	CDOT	3 365-7100	Ken.Wised@dot.state.co.us
38.	Bill			
39.	Mary Jo			
40.	Jim Hanson	PBS & S	303-221-7275	SHANSON@PBSST.COM
	Pete Steucson	CHZ	303/250-4753	Pete.Steucson@PCHZM.COM



MEETING ROSTER

DATE April 17, 2007

SUBJECT I-70 West Truck Chain Station Stakeholder's Meeting

	Name	Organization	Telephone	E-Mail Address
41.	SCOTT HERNANDEZ	C.S.P.	303 273 1679	scott.hernandez@cdps.state.co.us
42.	Paul Friessen	PBS & J	303-221-7275	dfriessen@pksj.com
43.	Dave Millar			dmillar@pksj.com
44.	Andrew Hancin	Citizen	720-286-5146	ahancin2@citizen.com
45.	KEVIN STARKS	AT&T	303 770-7201	KSTARKS@THKASSOC.COM
46.	Pat Noyes	PN Assoc	303 440 8171	Pat@patnoyes.com
47.	DAVE WOOLGERS	F.S. Police	303-567-4291	BliceHizf@IDANOSPANGLSCO.COM
48.				
49.				
50.				

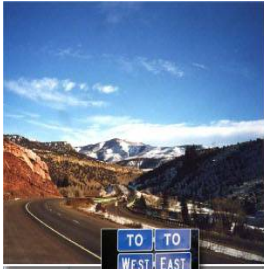

## **I-70 Context Sensitive Solutions**

# **I-70 Mountain Corridor Chain Station -2 Workshop Summary March 3, 2008 - DRAFT**

## Introduction and Background

The Colorado Legislature passed HB07-1229 Bill in 2007. This law puts into effect stricter fines for truck drivers who do not use chains when the chain law is in effect. The goal of this legislation is to improve the operations during winter months of the major interstates within Colorado.

This law has implications for the I-70 Mountain Corridor. One particular impact for the I-70 Mountain Corridor is the need for more chain-up and chain-down stations and for improvements to the existing stations. The Colorado Department of Transportation Regions 1, 3 and 6 staff are responsible to plan, design, operate, and construct the needed chain station improvements. As a result, Phase 1 improvements were designed and constructed for operations that went into effect for the winter of 2007/2008. Further improvements are currently being considered for implementation prior to the winter of 2008/2009 and later. Phase 2 improvements, primarily targeted for implementation for the winter of 2008/2009, would focus on lighting the chain stations.

To address the multi-faceted nature of these stations and arrive at a mutually acceptable design and phasing plan for these chain stations, a Context Sensitive Solutions approach was employed for Phase 1 and helped inform Phase 2 activities.

The Phase 2 approach began with the CSS Corridor Management Team working with Region 1 and Region 3 staff to plan a half day workshop bringing together concerned stakeholders.

The workshop was held on February 25, 2008 and the many interests were represented. Invited attendees included representatives from the trucking industry, the local emergency medical response providers, the Colorado State Patrol, the Port of Entry, CDOT maintenance teams, the design team and the CDOT leadership for the corridor. This agenda was used to conduct the workshop.

Included in this summary are the comments, concerns, and ideas discussed during the workshop. Initial topics discussed previous chain station processes and decisions as well as the Context Statement and Core Values for the I-70 Mountain Corridor. The design elements that should ultimately be included in all of the chain station designs were discussed and a presentation made on lighting options. The workshop wrapped up with a discussion of specific concerns and interests at each chain station location and the considerations to be used to prioritizing the lighting construction package elements given the available funding.

### Agenda

<b>1:15 p.m. - 1:15 p.m.</b>	<b>Welcome and Introductions</b>
<b>1:15 p.m. - 2:15 p.m.</b>	<b>Chain Station and CSS Overview</b>
<b>2:15 p.m. - 3:30 p.m.</b>	<b>Lighting Design</b>
<b>3:30 p.m. - 4:30 p.m.</b>	<b>Lighting Prioritization and Wrap up</b>

## Design Issues Summary

The following is a summary of issues and concerns identified by attendees as important design considerations.

**General Comments:**

- Prioritize lighting at critical locations based on:
  - Safety
  - Frequency of use
  - Source of power
- Physical separation and focused points of access are important to safety
- Communication through signing is important
- Monitor chain stations with CCTV
- Invest in lighting for shorter term needs only if future separation is a long term solution (minimize throw-aways)
- Operational issues should be addressed prior to lighting
  - EB 228
  - EB 219
- Use HAR 530 to provide information to truckers
- Send chain law information to satellite radio stations and Qualcom
- Consider reconfiguring East Vail lighting
- When designing stations, consider locating so overflow parking is downstream of the chain station area
- Look at chain station design and location in conjunction with closure location decisions and logistics
- Use shields to reduce glare to adjacent through traffic and intrusion into adjacent properties (especially in residential and wildlife sensitive areas)

**Specific Locations Eastbound:**

- MP 177 - Consider upgrading existing lights with new standards. Check viability of VMS board signing locations (recommend MP 175 and west of Dowd Canyon). Install/integrate variable speed limit signs into fiber optic backbone
- MP 183 - No critical issues. Install lighting.
- MP 184 - No lighting in 2008. No power source. Install/integrate variable speed limit signs into fiber optic backbone
- MP 187 - No lights (no power) or signs. Nothing until wildlife study is completed. Keep for interim use as safe haven for heavy truck tow program.
- MP 195 - Install lighting
- MP 203 - Separated. How much is it used? Install lighting
- MP 205 - Not separated, high use, install lighting (high priority)
- MP 219 - Separate before lighting. Need to develop an ultimate plan (note-continues to be high usage area)
- MP 228 - Look at operations and install lighting to support improved operations (e.g. install lighting to support use of the east end of station).
- MP 241 - Install lighting (high priority). Need to evaluate luminaries' brightness (400w) in conjunction w/existing high mast lights.
- MP 251 - Lower use/lighting priority

**Specific Locations Westbound:**

- MP 263 - Contact Region 6

- MP 260 – Contact Region 6
- MP 254 – Install lighting
- MP 228 – Install lighting. High priority. Design to support operations. Consider multi use
- MP 223 – Install lighting. Lighting would be beneficial to support operations and use
- MP 221 – Low priority. Wildlife issues. Requires further consideration. Discourage multi-use (e.g. hunters) w/ appropriate short term parking signage
- MP 219 – Low priority for lighting. Need to develop an ultimate plan
- MP 213 – Used a lot. Should light for multi use. Install lighting. Need to evaluate luminaries’ brightness (400w) in conjunction w/ existing high mast lights. Move location out of slide path. Consider impacts to wildlife.
- MP 197 – Install lighting
- MP 177 – Install lighting (pending working with the Town of Vail and homeowner association)

## **Workshop Wrap Up**

The conclusion of the workshop was a recap of the group’s discussions. The group has several information requests of the project team and interest in staying informed on the next steps taken.

The following commitments were made to the group.

The Chain Station Design Team will:

Post the workshop Power Point on the I 70 CSS website

Post the Chain Station FIR plans on the I 70 CSS website

E-Mail all invitees/ attendees a summary of the comments captured at the Workshop

Distribute a draft matrix for review to be sure we are looking at the right factors for prioritization

The CSS Team will:

Work with the Chain Station Design Team on the decision matrix

Get back to the community regarding the decisions made

## **Actions Forward**

The results of this report will be distributed to those participating. Performance of the completed chain stations will be monitored throughout the current winter season. Resulting adjustments/revisions in performance standards will be incorporated in future chain station installations accordingly.

**ATTACHMENT A**  
**SUMMARY OF WORKSHOP 'FLIP CHART' COMMENTS**

**General Comments:**

- Prioritize lighting at critical locations based on:
  - Safety
  - Frequency of use
  - Source of power
- Physical separation and focused points of access are important to safety
- Communication through signing important
- Monitor chain stations with CCTV
- Invest in lighting to accommodate future separation
- Operational issues should be addressed prior to lighting
  - EB 228
  - EB 219
- Use HAR 530 to provide information to truckers
- Send chain law information to satellite radio stations and Qualcom
- Consider reconfiguring East Vail lighting
- When designing stations, consider locating so overflow parking is downstream of the chain station area
- Look at chain station design and location in conjunction with closure location decisions and logistics

**Specific Locations Eastbound:**

- MP 177 - Consider re-lighting with new standards. Check signing locations, recommend MP 175 and west of Dowd Junction)
- MP 183 - No critical issues
- MP 184 - No lighting in 2008. No power source.
- MP 187 - Nothing until wildlife study is completed
- MP 195 - Light
- MP 203 - Separated. How much is it used?
- MP 205 - Not separated, high use, high priority
- MP 219 - Separate before lighting. Need to develop an ultimate plan
- MP 228 - Look at operations and light to support improved operations.
- MP 241 - Priority
- MP 251 - Lower use

**Specific Locations Westbound:**

- MP 263 - Contact Region 6
- MP 260 - Contact Region 6
- MP 254 - Priority
- MP 228 - High priority. Support operations. Consider multi use
- MP 223 - Lighting would be beneficial to support operations and use
- MP 221 - Low priority. Wildlife issues. Requires further consideration
- MP 219 - Low priority. Need to develop an ultimate plan

- MP 213 - Used a lot. Should light for multi use. Move location out of slide path. Consider impacts to wildlife.
- MP 197 - Light it
- MP 177 - Work with the Town of Vail and homeowner association

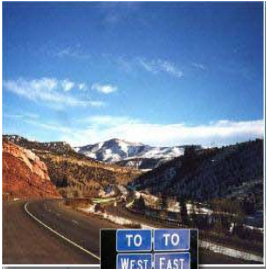

# I-70 Context Sensitive Solutions

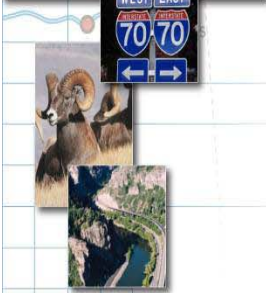

## I-70 Mountain Corridor Chain Stations

April 11, 2008

DRAFT



## Welcome and Introductions

Peter Kozinski welcomed the attendees and said that the main purpose of the meeting was to resolve CDOT and Stakeholder concerns for lighting at the Herman Gulch and Bakerville Chain Stations. Peter stressed that CDOT is committed to reducing impacts to wildlife and improving traveler safety at all chain station locations.

At the present time there is only one chain station on I-70 with lighting and the lack of lighting causes safety issues for truckers chaining up/down.

The safety of the traveling public is also a concern with unlit/unsigned Chain Stations. If stations aren't clearly identified, the truckers are using the shoulders and on/off ramps for chaining. It is also very important to give the truckers parking space to get them off the road during I-70 closures.

Improving the chain stations at this time may represent temporary improvements until the Collaborative Effort makes a recommendation and planning around the recommendation can be done.

Peter announced that funding has been found to build a physical separation at the 219 EB Herman Gulch station. He will make the design available to the group when it is complete. Peter also stated CDOT's desire to form a working group to put a more comprehensive plan together for the chain stations.

\$3.5M has been set aside for lighting as many of the sixteen chain stations as possible this year. The goal is to have the Chain Station lighting work completed this summer. There should be enough money to complete approximately seven stations. CDOT will make a final plan set with the lighting available to all attendees.

Bernie Guevara identified CDOT's top priority Chain Station. The locations and issues are:

1. EB 205 Silverthorne. Consensus that this is the top priority.
2. WB 228 Georgetown. This station will have lighting on both sides of the chain station. The Georgetown Design Review committee approved the lighting on April 10<sup>th</sup> (with comments).
3. 219 EB Herman Gulch. This will be separated from the highway, widened and will have lighting.
4. 219 WB Herman Gulch. This was identified as a low priority on the Phase 2 matrix.

On a site visit, Cindy Neely noted that there are two mudslide areas at this location. She wondered if the USFS Herman Gulch Trailhead parking area could be used as a chain station. FHWA may have issues with interstate access. Peter Kozinski and Carol Kruse will make a site visit to confirm if the Forest Service is agreeable to using this as a chain station.

This location is within a LIZ running from MP 216.7-220.8. Two lynx were hit on each end of the linkage. Lynx cross where the trees are and will not be affected by the addition of more pavement. The Forest Service suggested monitoring wildlife at this location. This will be addressed by ALIVE.

5. 195 EB Copper Mountain.

6. 221 WB Bakerville. This is on the edge of Linkage Interface Zone (LIZ). It was recommended that this station be lit instead of 223 since it is a bigger location.
7. 177 WB Vail Pass. Big safety concerns here, recent accident/fatality. There is no power here and it will cost \$500K to add. This station will be widened this year but not lit. 184 EB VMS sign will be added this year, lights later. 183 EB will be getting lights. Funding for this project is from a different funding source.
8. 241 EB West of Twin Tunnels. Matrix needs to be updated to “wildlife – yes”. This is on the west side of the tunnels, last chance to chain up before Floyd Hill. It is 100 yards from the tunnel entrance. There currently is a high mast at this location. The lighting will not light the land bridge over/above the chain station. Tunnel lighting is always on but the chain station lighting will only be on when Chain Law is in effect.

The Forest Service voiced concern about the cumulative effect of the combination of high mast/median and chain station lighting. They were also concerned if the Herman Gulch, Bakerville and Twin Tunnel chain stations were located in the National Forest.

9. 223 WB. There is good visibility of this chain station even without lighting. This location will be moved to a low priority. Bernie Guevara agreed that this station could be moved to a low priority.

213 WB west of EMJT was recommended as a medium priority. This location could also become a multi-use location in summer.

221WB Bakerville be lit instead of 223WB.

196 WB Copper Mountain was discussed as one to light if there is money left over. This location currently does not have power which is the biggest cost, therefore, this is unlikely to be a part of the current lighting project.

The Forest Service would like a commitment in writing from CDOT that the design and construction of the chain stations can be modified with future projects.

### **Decisions Made**

After discussion the group agreed the top ten chain station priority locations are:

1. 205 EB Silverthorne
2. 228 WB Georgetown
3. 219 EB Herman Gulch
4. 219 WB Herman Gulch
5. 195 EB Copper Mountain
6. 221 WB Bakerville
7. 183 EB (Lights) & EB 184 (Sign)
8. 241 EB Twin Tunnels

9. 213 WB West of EJMT (now a medium priority)
10. 196 WB Copper Mountain (if funding is available)

**It was agreed that CDOT could move forward with the Construction Plans.**

**Action Items**

Tyler Weldon/CDOT will work with the Forest Service on jurisdiction and concurrence for all chain station locations.

Dave Wieder/CDOT needs to verify with CDOT PM Russ Cox about the Twin Tunnel lighting.

Peter Kozinski will draft the letter for the Forest Service confirming the design and construction of the chain stations can be modified with future projects.

The meeting was adjourned at 3:45 pm.



## **I-70 Mountain Corridor CSS Chain Station Working Group Meeting**

Date: September 22, 2008

Location: Georgetown Community Center

Attendees: See Attached Sign-in Sheet

### **Welcome and Introductions**

The meeting started with a welcome by Peter Kozinski and introduction of attendees. Bernie Guevara gave the Group a brief history of the chain station project.

Bernie said that the chain requirement will now extend to Dotsero. A truck parking location is being designed for this location which will minimize the truck congestion when Vail Pass is closed. He also mentioned that a truck parking location on the eastern part of the corridor would be a good idea but a site needs to be identified. Improvements to lighting, the VMS signing in the corridor and at the chain stations are also in the works.

There is a new product "Auto Sock" which significantly reduces the chain up time but still has limited desirability on dry pavement. CDOT will implement vendor services for truckers by supplying chaining supplies and to assist with putting chains on as well as their removal. These will supplement existing heavy tow and courtesy patrol services. The different levels of enforcement fines were also reviewed.

### **Review of Objectives, Issues and Concerns**

The group reviewed the objectives, issues and concerns that were identified in previous meetings (attached). The group agreed "Overflow parking should be downstream of the Chain Station Area" should be reworded to "Design overflow parking to minimize confusion". Each location should be designed for site-specific needs.

In addition, the group agreed that there should be an additional category for operational strategies because this will require additional money and staff.

All agreed that Chain Stations should not be used as scenic stops for travelers unless they are already designated as such and additional amenities (e.g. trashcans, bathrooms) should be looked at closely for maintenance challenges prior to inclusion.

The group had no other changes or additions to the list.

Discussion followed on how locations could be prioritized. The group discussed three different possible approaches to prioritization:

1. By location/ # of spaces required
2. Improvements at specific locations
3. Specific improvements at all locations
4. Operational strategies

CDOT retains the responsibility of prioritizing locations based on the guidance in the Chain Station Plan. It was agreed that a Plan and process should provide a clear understanding of what corridor stakeholders expect all chain stations to look like and consistently applied for future work.

The group agreed that following the CSS Decision Making Process for new stations would provide guidance to CDOT for stakeholder involvement and insure consistency.

### **Overview of Existing Chain Stations**

The group learned that the proposed location EB 187 was eliminated due to direct conflict with the proposed wildlife overpass and minimal demand near the top of Vail Pass. The name of the Chain Station at MP 219 has been changed from Herman Gulch to Watrous Gulch to more accurately reflect the location.

### **Typical Sections and Amenities**

The group reviewed the list of amenities that could be added to each site:

- Lighting
- Signing
- Facilities
- Landscaping
- Fencing and/or gates
- Emergency Call Box

It was suggested and the group agreed on the following:

- Landscaping should be low grasses only, no trees
- Fencing decisions should be made site by site to accommodate issues such as ROW or wildlife crossings
- Gates should be considered in all station designs (with separation areas) and should not become an additional burden for maintenance crew's priority of clearing snow. Future automation is a consideration if safety issues can be adequately addressed.
- Emergency Call Boxes should only be added in "dead zones" or remote locations
- Rumble strips should be considered
- Delineators should be considered
- Comfort stations should only be included at the truck parking locations

Three proposed Typical Chain Station concepts were presented. The group referred to the concepts as 1, 2 and 3, which is the order they were in the packet, not the order of preference. The group had the following comments and concerns:

### **Chain Station Directly Adjacent to Proposed I-70 with One Parking Lane (#1)**

- Concern that this would result in continuous chain stations along the corridor
- Concern that this would be a “band-aid” because it is cheaper to build
- Physical separation from the interstate is needed for trucker safety
- A rumble strip should be added
- Creating a physical barrier with snow would be difficult because striping would be hard to see in a snowstorm

### **Chain Station Separated from I-70 with One Driving lane and One Parking Lane (#2)**

- Using a ditch to create the separation area is safer than using jersey barriers and easier to maintain
- Separation ditch would provide catchment areas for sediment, snow storage and magnesium chloride
- Creating a physical barrier with snow would be possible in the separation area
- Wildlife in separation area could be a concern due to the wider section

### **Chain Station Separated from I-70 with One Driving Lane and Two Parking Lanes (#3)**

- Same as #2

The group agreed that separation at all chain stations should be:

- Clearly and visually defined
- Offset
- Unpaved
- Adequate width
- Defined with single entrance and exit points

In addition, the group agreed that the concepts 2 & 3 would be the preferred designs and variation of features and minimums would be clarified for each location.

Design Concept #1 should only be used as a “last resort” and would require review and acceptance by the stakeholders.

Retrofits should be either #2 or #3 with phase out of Option #1.

The PEIS Preferred Alternative cannot be sacrificed for Chain Stations. Stations will have to be relocated or accommodated at their current locations accordingly.

### **Location by Location Discussion**

Each chain station location was discussed and resulted in the following comments:

A clarification was made that in the chain station description “Pending Lighting” means that the lighting is now funded as part of current construction on the corridor and “Future Lighting” may be done sometime in the future.

Water resource issues should be a concern at all chain stations.

Operations Package or Options need to be included in the Plan – Signing, strategies, pavement marking, snow plowing, etc.

Real time monitoring and variable message signs to indicate space availability is a high priority.

**EB MP 177** – Upgrade of lighting to current standards being constructed elsewhere is a high priority. Congestion during closure of Vail Pass has been addressed in the Incident Management Plan. Future highway improvements could result in sections of the old interstate being used as a chain/parking station.

**EB MP 183** – This station gets a lot of use in spring and fall. Electricity is available and lighting is pending. A variable speed limit sign was included in Phase 1A. An auxiliary lane should be added to the future design. Runoff from sand and mag-chloride is a concern.

**EB MP 184** – Wildlife issues. There is electric at this site but only enough for the sign, not lights. Auxiliary lane could be added in the future. Runoff from sand and mag-chloride is a concern.

**EB MP 195** – First official chain-down station after Vail pass. Only five spaces. No opportunity to widen because of the adjacent ponds and wetlands. Low priority, will be moved when highway is widened.

**EB MP 203** – Name should be changed from “Dillon Interchange” to “Lake Dillon Scenic Overlook”. Lighting should be “Future” not “Pending”. The correct number of spaces is 15.

**EB MP 205** – Lighting is pending. Signs should be added on the entrance ramp to warn drivers of upcoming chain station. Wetland and water resource issues.

**EB MP 219** – This was supposed to be the eastbound model (similar to WB Georgetown) but was not built as previously discussed. The group would like to see this be retrofitted to a Typical Section #3. Operational issues because of separated and previously built non-separated sections. There is plenty of room for a wider separation. Peter Kozinski will investigate to see if this site can be retrofitted to a wider separation, otherwise adequacy of operations will be monitored throughout the winter.

**EB MP 228** – Future lighting not to be built adjacent to the gore area. Current configuration should be reviewed to improve operations with the on ramp and weaving movements. Lighting will have shields.

**EB MP 241** – More chain-up than chain-downs happen here. Actual location of chain station as it appears on the aerial photo should be field verified.

**EB MP 251** – Chain-up location for Floyd Hill. Not a high use site.

**WB MP 177** – Chain-down location. New this season. Sand storage from Black Gore Creek project is being used as a sound buffer for nearby homes.

**WB MP 197** – Multi-use chain station and scenic area. Fills up quickly. Will not be expanded due to limited available space.

**WB MP 215** – Sign is at MP 216, chain station is at MP 213. Name should be changed to WB MP 213.

**WB MP 219** – Future climbing lane location. Will need to relocate. Wildlife concerns.

**WB MP 221** - Future climbing lane location. Will need to relocate. Wildlife concerns.

**WB MP 223** – Future climbing lane location. Will need to relocate. On a curve. Need sign at this location to move trucks to next chain station at times when spaces are available.

**WB MP 228** – Great job on the design! Lights will be installed soon. Signing could be improved to enhance operational aspects.

**WB MP 254** – Oldest location (original construction). Separation from I-70 by guardrail.

**WB MP 260** – Directly adjacent to I-70. No additional lighting planned.

**WB MP 263** – North of 20<sup>th</sup> Avenue. Neighborhood nearby; no additional lighting planned.

### **Decision Process**

Mary Jo Vobejda explained the Decision Process insures stakeholder involvement in the life cycle phases of a project from planning to operations and maintenance. A six-step process will be used for all phases of projects on the corridor and was used for this meeting.

Depending on the project, there can be several different teams involved. Mary Jo stressed that a Project Leadership Team will not make decisions on projects. They will move the project forward and insure the decision is made in a collaborative way.

### **Summary and Wrap-up**

Bernie Guevara asked for clarification on what type of projects would require stakeholder input. The group agreed that routine maintenance projects generally do not need reviewing but they would like to be involved in projects that make a change to the highway or have a visual impact on the corridor.

The group would like to see “triggers” included in the Chain Station Plan so it is very clear to CDOT if a project needs stakeholder review.

Bernie also asked for clarification on what group or meeting should receive information on the projects. Since there are multiple meetings in the corridor that involve different stakeholders, the group thought the County Coordination Quarterly Meetings might be the correct group.

Work will begin on drafting the Chain Station Plan. Prior to reconvening the group, the Plan will be sent out for review.

The group indicated that they would prefer to have the next Chain Station Meeting during a week when there are no other CDOT Meetings.

The meeting was adjourned at 2:20 pm.



<b>Name</b>	<b>Organization</b>	<b>Attended</b>
Binder, Terri	Club 20	X
Brown, Allan	PBS & J	X
Fischer, Aaron	CDOT	X
Gaubatz, Kathleen	Clear Creek County	X
Gerak, Janet	CDOT	X
Giezentanner, Keith	USFS	X
Guevara, Bernie	CDOT	X
Hestekin, Patti	Georgetown Trust/Bakerville Heritage Area	X
Hoftiezer, Scott	CDOT	X
Johnson, Kristopher	Design Workshop	X
Kavanaugh, Jamie	Clear Creek EMS	X
Kozinski, Peter	CDOT	X
Michael, Alison	USFWS	X
Neely, Cynthia	Town of Georgetown	X
Noyes, Pat	Pat Noyes & Assoc.	X
Olsgard, Patti	CMCA	X
Raitano, Flo	I-70 Coalition	X
Sakaguchi, Tracy	CMCA	X
Santos, Richard	FHWA	X
Shanks, Kevin	THK & Associates	X
Sobhi, Saeed	CDOT	X
Stearns, Chuck	Town of Georgetown	X
Stevenson, Dave	CH2M HILL	X
Urban, Melinda	FHWA	X
Vobejda, Mary Jo	CH2M HILL	X
Williams, JD	Colorado State Patrol	X
Yearsley, Danielle	CH2M HILL	X

## **Chain Station Design Principles**

### Summary of Objectives from Previous Workshops

#### **Improve Safety**

- Signing minimizes chaining activities in unsafe locations
- Physical separation between the travel lanes and the parking areas
- A single exit and entrance point for users of the Chain Station
- Reduction in speed limit available with ITS signing
- Additional spaces
- Education and enforcement
- Design for safe operations with other interstate functions and facilities
- Overflow parking should be downstream of the Chain Station area

#### **Build Locations as Models**

- Construct a limited number of sites with excellent design, rather than larger number built with poor design, to show quality of work and build support for additional funding

#### **Provide for Multi-use Where Appropriate**

- Chain Stations
- Disabled vehicles
- Enforcement activities
- Scenic stops for travelers

#### **Minimize Environmental Impacts**

- Noise
- Air quality
- Water quality
- Wildlife

#### **Provide Lighting**

- Use only during snow storms when the Chain Law is in effect
- Lighting should aid the truckers in chaining their vehicles
- Minimize lighting affects on wildlife and residents
- Minimize maintenance requirements

#### **Provide ITS Signing**

- Can be in effect only when needed
- Will be more noticeable during snow
- Can serve multiple purposes – speed limits and information

#### **Consider Courtesy Service Program**

- Chains and chaining services
- Tows
- Information
- Snow plowing

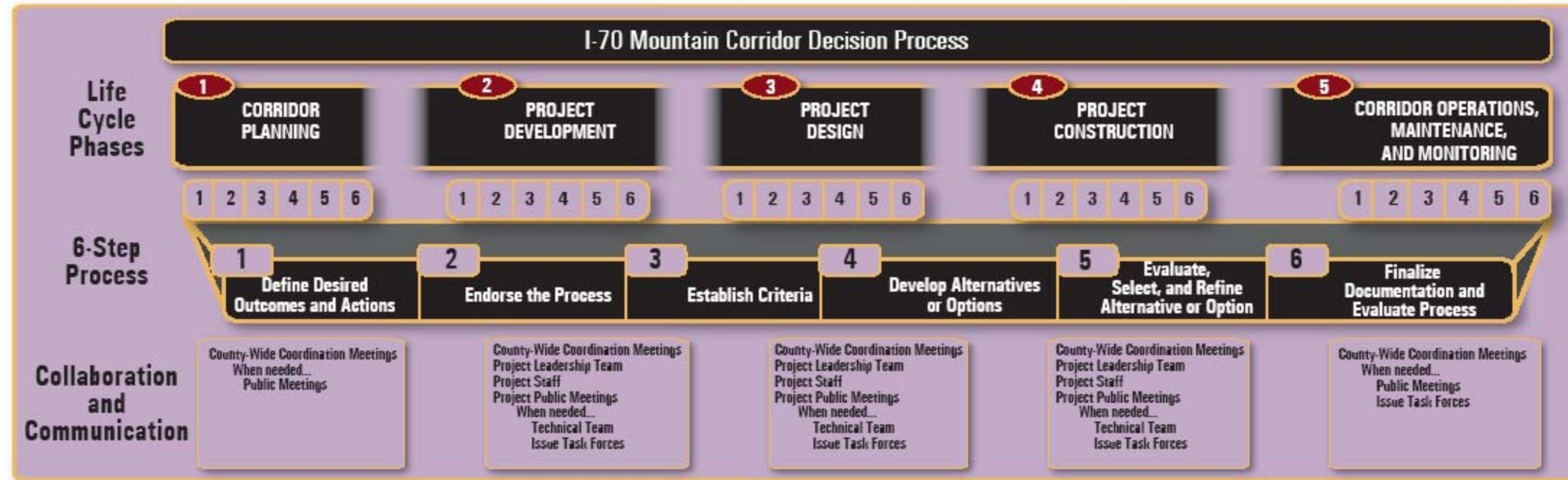

**Life Cycle Phases**

- Phase 1** Corridor Planning integrates with statewide planning efforts, champions corridor-wide planning, and promotes consistency among local planning efforts. Deliverables include the Programmatic Environmental Impact Study and other corridor-wide planning studies.
- Phase 2** Project Development brings improvement concepts, environmental documents, and mitigation strategies to completion. Deliverables include Tier 2 environmental documents and feasibility studies, as well as a level of preliminary design.
- Phase 3** Project Design develops construction plans for a project. Deliverables include project design plans, specifications, and cost estimates.
- Phase 4** Project Construction safely builds a functional transportation facility. Deliverables include completion of the physical improvements, work acceptance, as-built drawings, and project closure documents.
- Phase 5** Corridor Operations, Maintenance, and Monitoring will inspect, monitor, assess, manage, and maintain completed facilities, as well as provide feedback to Phase 1 Corridor Planning and Phase 2 Project Development for incorporation into future projects. Deliverables include monitoring feedback and program documents; for example: incident management plans, mowing and paving programs, and safety inspection reports.

**6-Step Process**

- Step 1** **Define Desired Outcomes and Actions**  
Using the *CSX Guidance Manual* and other relevant materials, establish goals and actions, define terms to be used, and identify decisions to be made. Using established parameters and an existing framework -- goals, actions, and decisions to be made -- develop the specific process to be used during decision making, including teams, team roles, and interactions during the process.
- Step 2** **Endorse the Process**  
For each team: Establish participants, their roles and responsibilities, and commitments and accountability. Endorse the process by discussing, possibly modifying, and then finalizing with all teams the desired outcomes and actions to be taken. Clarify terms and expectations for use in the process.
- Step 3** **Establish Criteria**  
Review Corridor Context Statement, Core Values, and CS Criteria Guidance. Work with team participants to establish the specific vision, goals, and criteria: a good criterion is measurable, is relevant to the project decision, and distinguishes between alternatives or options.
- Step 4** **Develop Alternatives or Options**  
Identify alternatives or options relevant to the desired outcomes, specific vision, and goals.
- Step 5** **Evaluate, Select, and Refine Alternative or Option**  
Analyze all alternatives and options by applying the criteria; then refine the final alternative or option.
- Step 6** **Finalize Documentation and Evaluate Process**  
Documentation should be continuous throughout the process. This step finalizes the documentation and serves as a debriefing with which to evaluate the process. Final documentation will include the process evaluations.

**Teams**

- Ongoing Collaboration and Communication**  
The Colorado Department of Transportation (CDOT) will partner with other county owners in convening County-Wide Coordination Meetings, which will include county, city, and town representatives who will meet on an agreed-upon schedule in order to discuss upcoming projects, ongoing projects, and maintenance activities.  
CDOT will organize Public Meetings that will be open to all stakeholders when their input is needed or when information is available for discussion.
- Ongoing Collaboration and Communication**  
The Project Leadership Team (PLT) will be a collaborative stakeholder team that leads individual projects. The Project Staff (PS) will be a multidisciplinary team that includes experts in planning, design, public process, and communication.  
CDOT will open Project Public Meetings to all stakeholders, who will be convened based on the project work plan.
- Optional Teams**  
Technical Teams (TTs) will be multidisciplinary teams that include experts in all of the Core Values. Projects with multiple issues and stakeholders may require TTs. The PS may act as the TT for smaller projects or projects that address a single issue, such as rock fall mitigation or pavement overlays.  
Issue Task Forces (ITFs) will be multidisciplinary teams that include stakeholders and experts in the Core Values surrounding a single issue. When a single or focused issue arises during a project, the project may require an ITF. That ITF will report its recommendations to the PLT or the PS, after which the ITF will be dissolved. The PS may be the ITF for a project addressing a single issue, such as updating an Incident Management Plan.

DRAFT

# Proposed Typical Chain Station Separated From I-70 with One Driving Lane and Two Parking Lanes

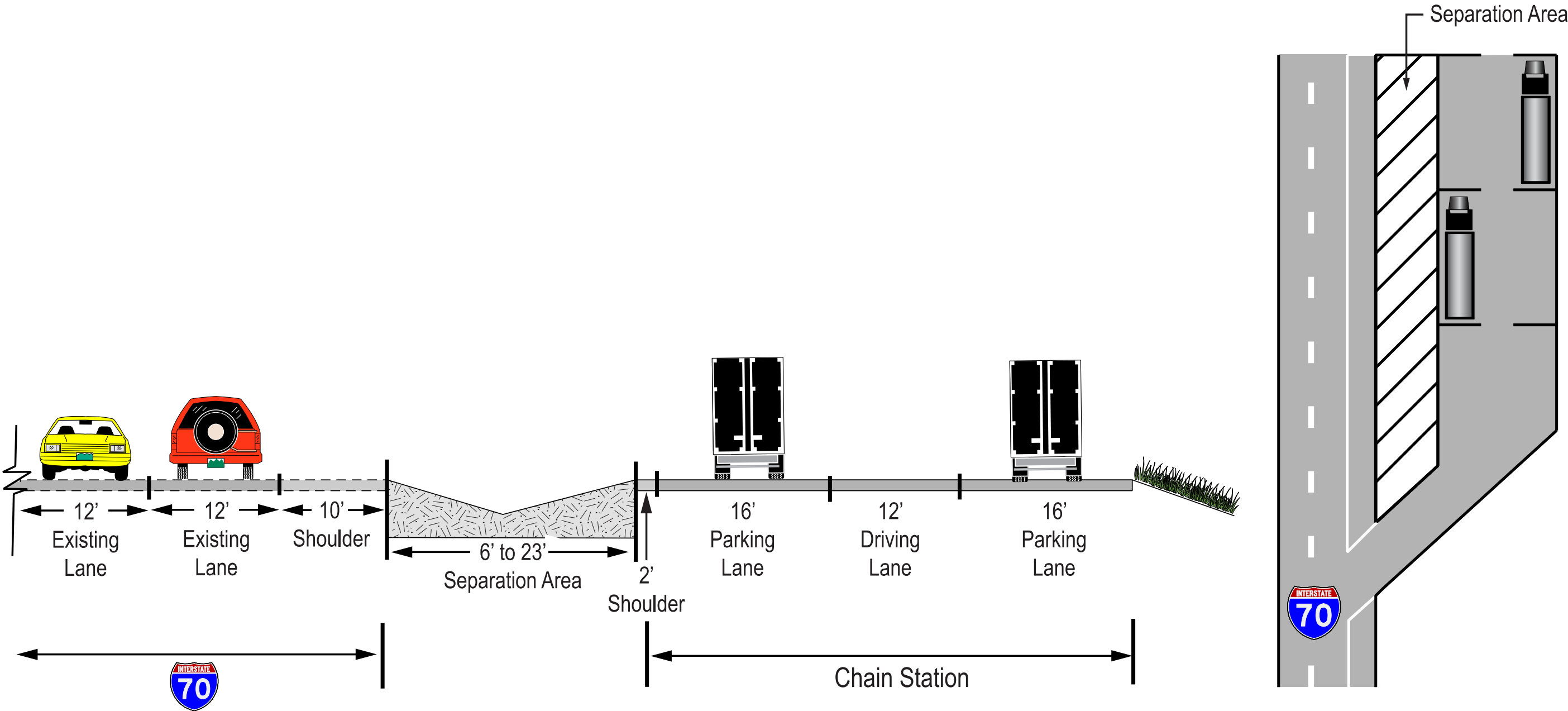

# DRAFT

## Proposed Typical Chain Station Separated From I-70 with One Driving Lane and One Parking Lane

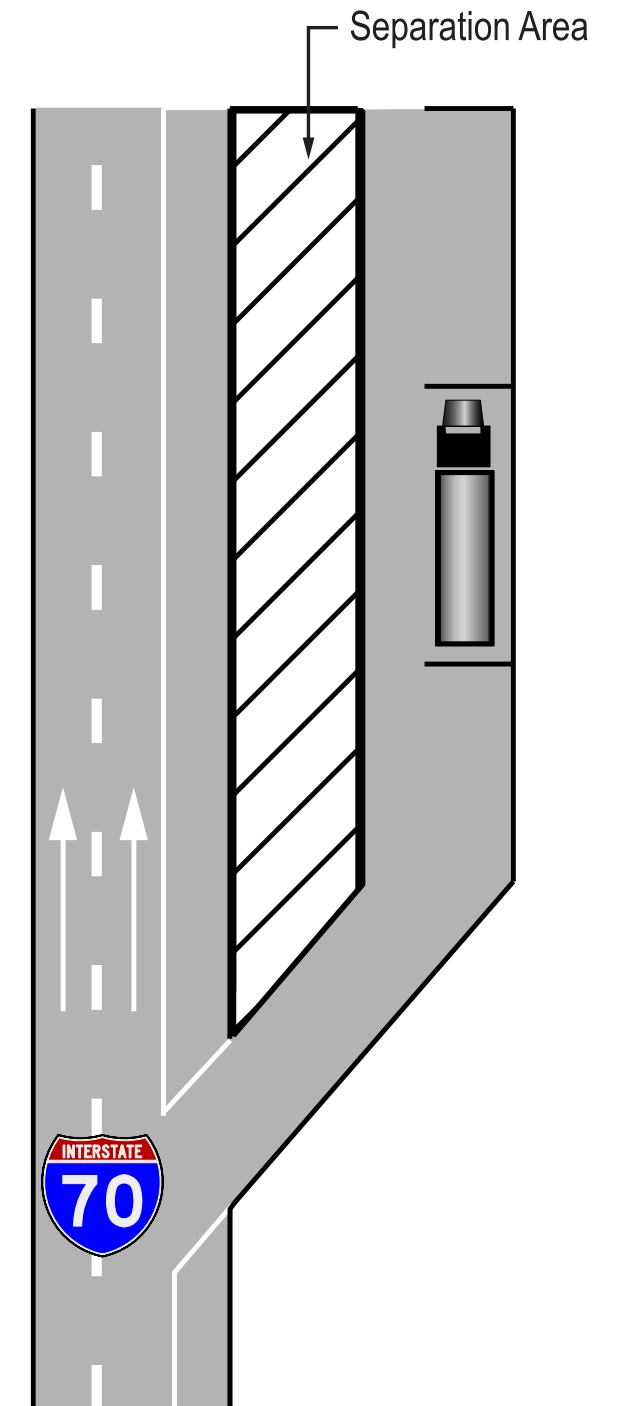
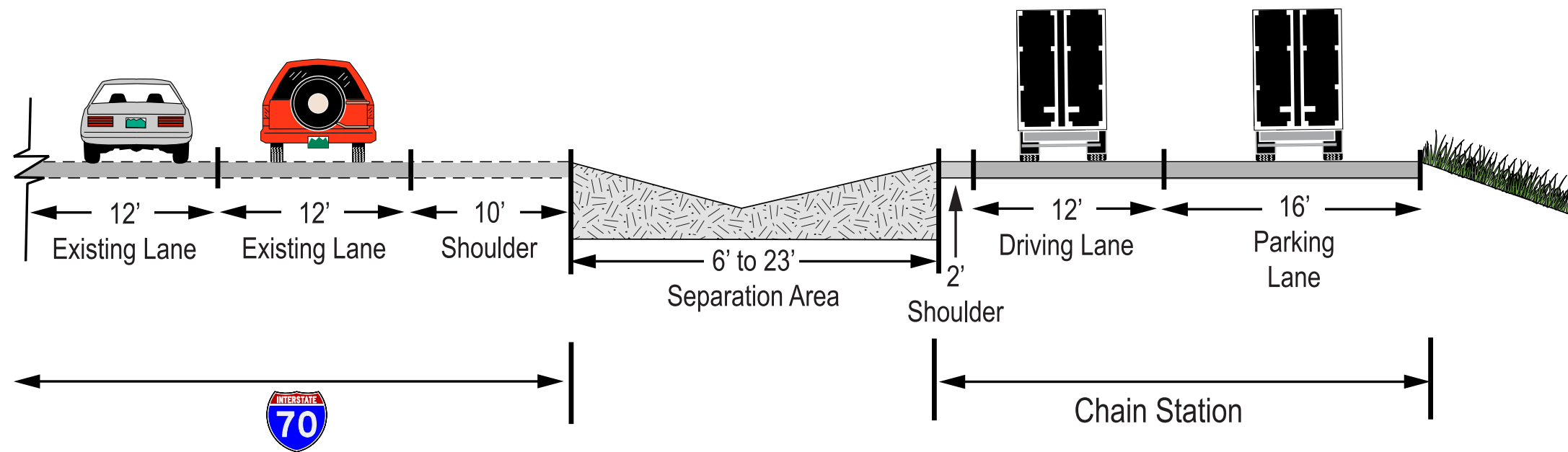

DRAFT

## Proposed Typical Chain Station Directly Adjacent to Proposed I-70 with One Parking Lane

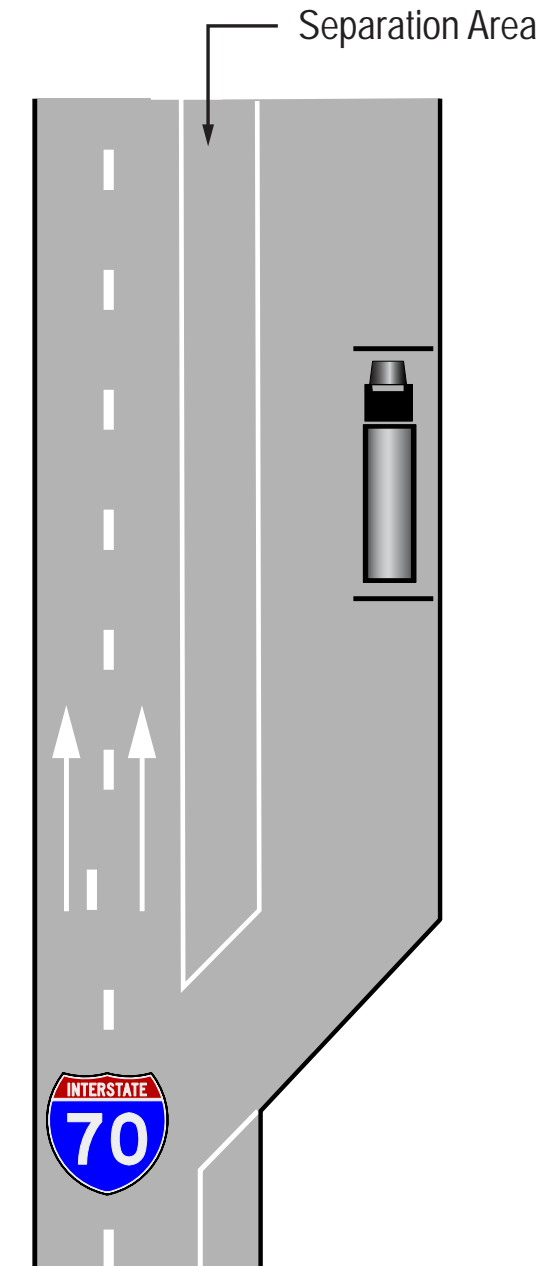
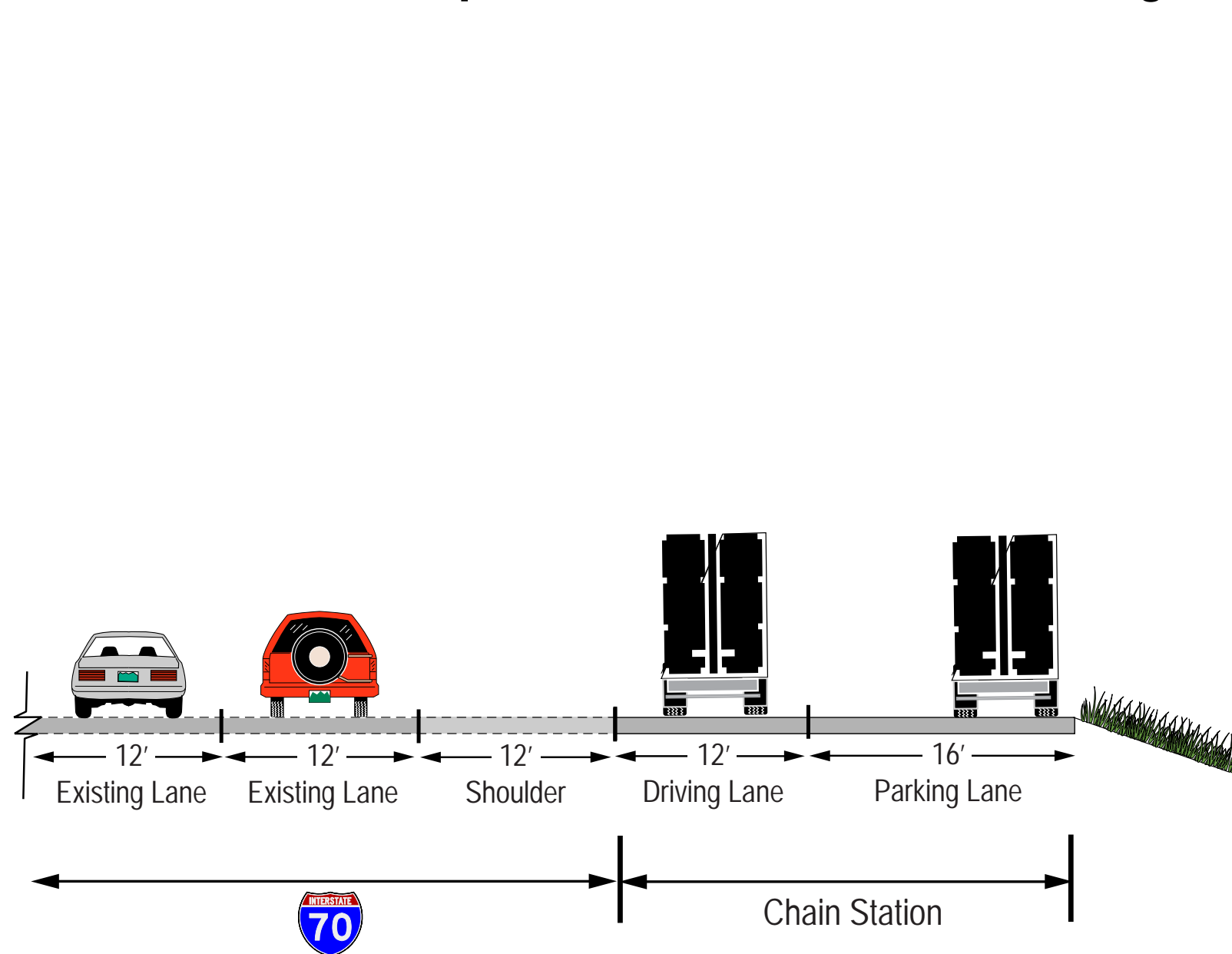

# DRAFT

## Proposed Typical Chain Station Separated From I-70 with One Driving Lane and One Parking Lane

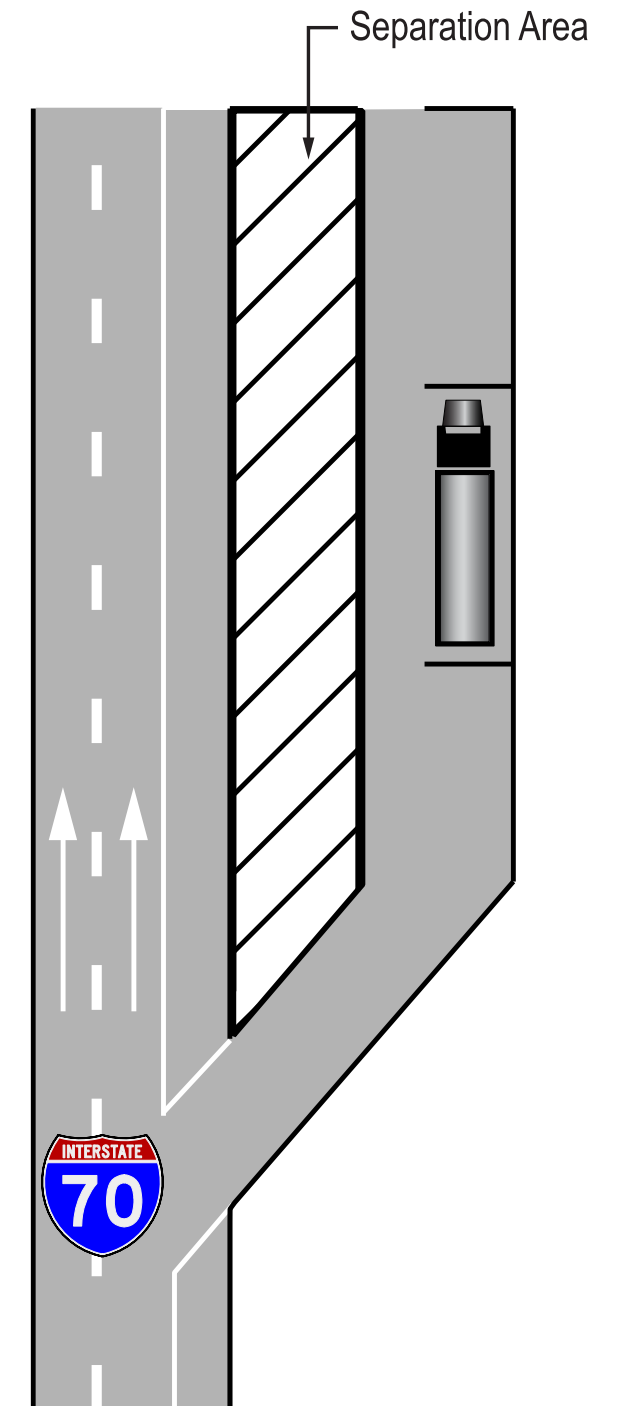
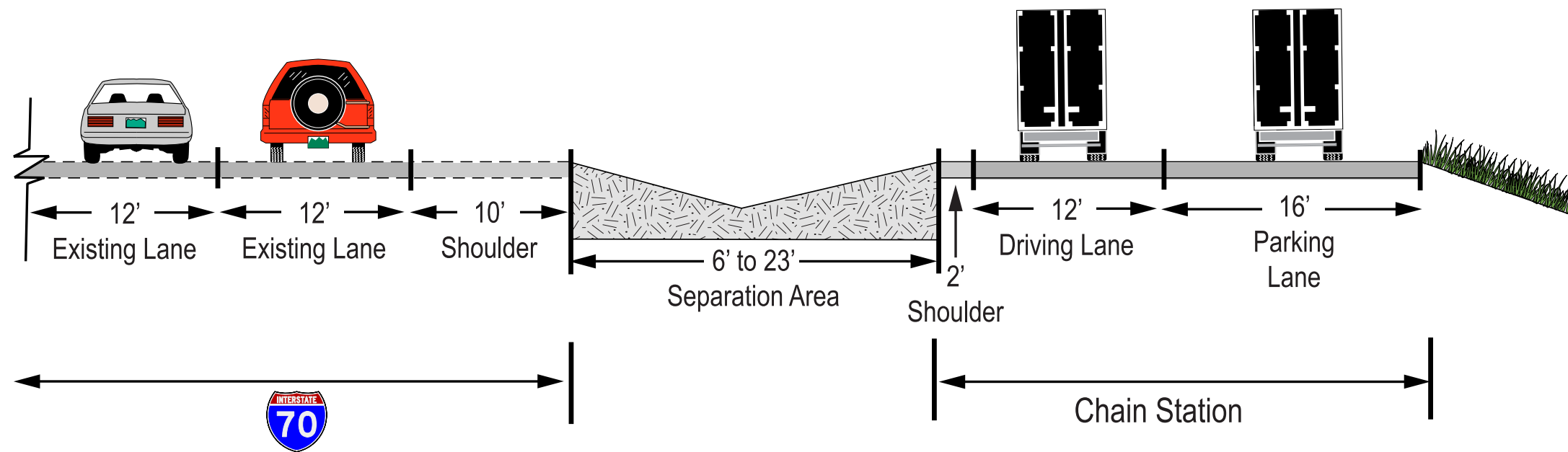

DRAFT

# Proposed Typical Chain Station Separated From I-70 with One Driving Lane and Two Parking Lanes

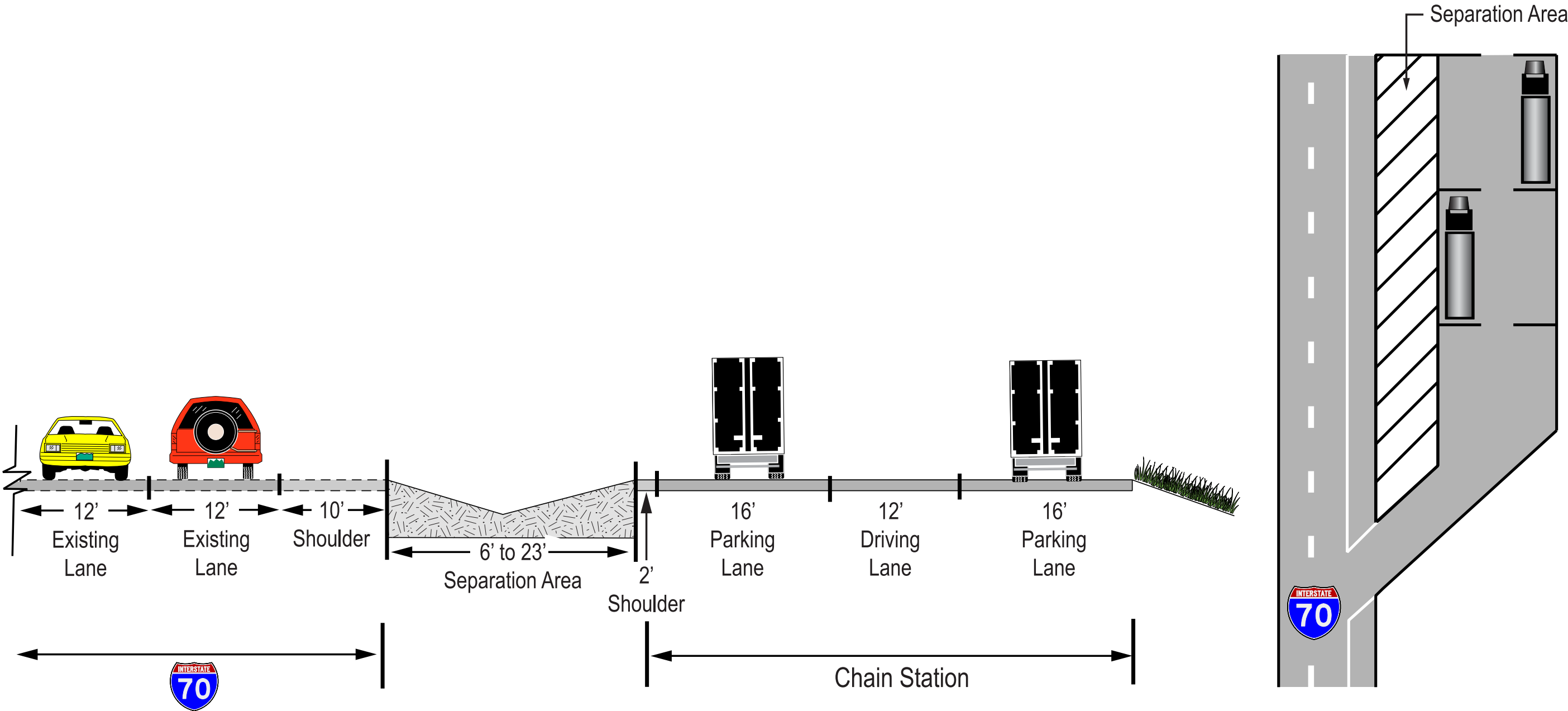



DRAFT

## Proposed Typical Chain Station Directly Adjacent to Proposed I-70 with One Parking Lane

