

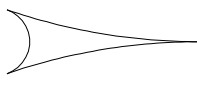

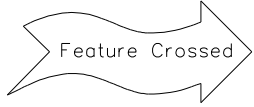









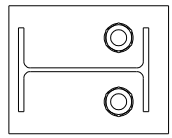
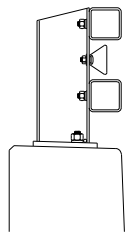
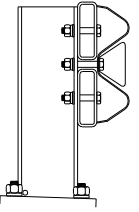
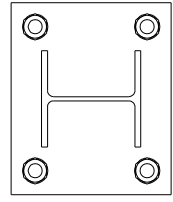
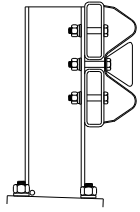
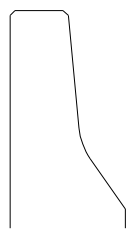
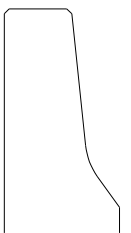
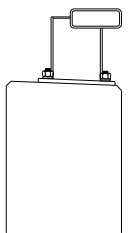
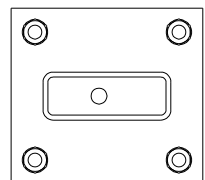
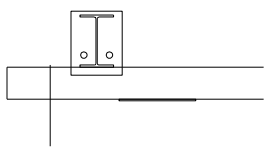
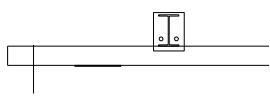
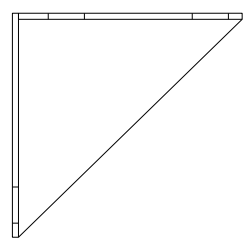
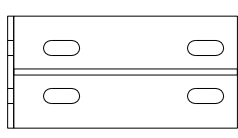
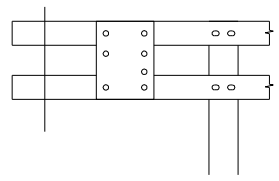

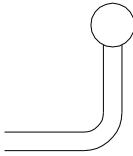
# CDOT BRIDGE CELLS

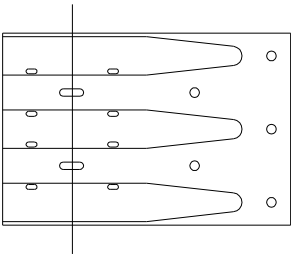
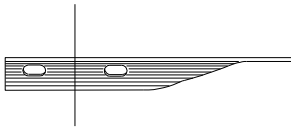
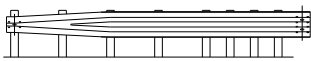
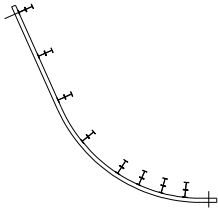
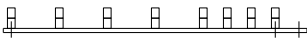
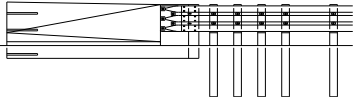
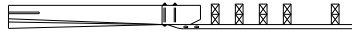
 <p>Arrows_Bridge Point Cell</p>	 <p>Arrows_flowarrow Point Cell</p>	 <p>Arrows_norharw1 Graphic Cell</p>	 <p>Arrows_norharw2 Graphic Cell</p>
 <p>Arrows_squig1 Point Cell</p>	 <p>Arrows_squig2 Point Cell</p>	 <p>Bridge_Rail-type-10-plan Graphic Cell</p>	 <p>Bridge_rail-type-10-with-curb Graphic Cell</p>
 <p>Bridge_Rail-type-3 Graphic Cell</p>	 <p>Bridge_Rail-type-3-plan Graphic Cell</p>	 <p>Bridge_Rail-type-3-with-curb Graphic Cell</p>	 <p>Bridge_Rail-type-4 Graphic Cell</p>
 <p>Bridge_Rail-type-7 Graphic Cell</p>	 <p>Bridge_Rail-type-8 Graphic Cell</p>	 <p>Bridge_Rail-type-8-plan Graphic Cell</p>	 <p>Bridge_Rail_10r-plan Graphic Cell</p>
 <p>Bridge_Rail_10r-plan-max Graphic Cell</p>	 <p>Bridge_Rail_10t-brace-side Graphic Cell</p>	 <p>Bridge_Rail_10r-brace-top Graphic Cell</p>	 <p>Bridge_Rail_10t-front-max Graphic Cell</p>

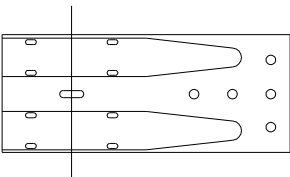
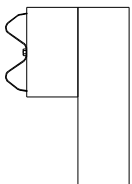
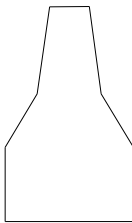
# CDOT BRIDGE CELLS

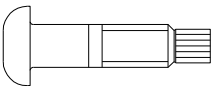
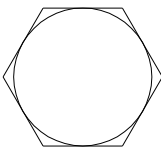
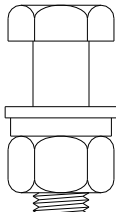
 <p>Bridge_Rail_10t-topplate-side Graphic Cell</p>	 <p>Bridge_Rail_10t-topplate-top Graphic Cell</p>	 <p>Bridge_Rail_bikerail Graphic Cell</p>	 <p>Bridge_Rail_thrie Graphic Cell</p>
 <p>Bridge_Rail_thrie-end Graphic Cell</p>	 <p>Bridge_Rail_thrie-endtop Graphic Cell</p>	 <p>Bridge_Rail_trans3g Graphic Cell</p>	 <p>Bridge_Rail_trans3g-maxradius Graphic Cell</p>
 <p>Bridge_Rail_trans3g-top Graphic Cell</p>	 <p>Bridge_Rail_transition elev- bridge type 7 to guardrail type 3 Graphic Cell</p>	 <p>Bridge_Rail_transition plan- bridge type 7 to guardrail type 3 Graphic Cell</p>	 <p>Bridge_Rail_type3 Graphic Cell</p>
 <p>Bridge_Rail_type3-end Graphic Cell</p>	 <p>Bridge_Rail_type3side Graphic Cell</p>	 <p>Bridge_Rail_type4 Graphic Cell</p>	 <p>bolts_34stud Graphic Cell</p>
 <p>bolts_78stud Graphic Cell</p>	 <p>bolts_78tc-bolt Graphic Cell</p>	 <p>bolts_seven eights inch _bolt head Graphic Cell</p>	 <p>bolts_seven eights inch_ bolt with lock and hard washer Graphic Cell</p>

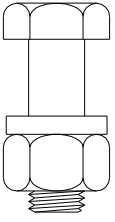
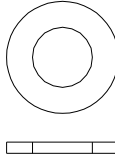
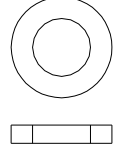
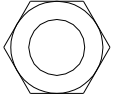
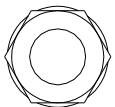
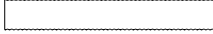
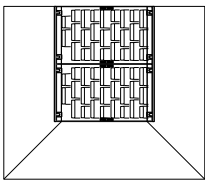
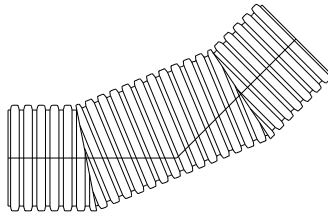
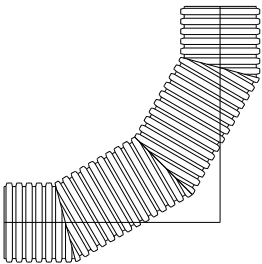
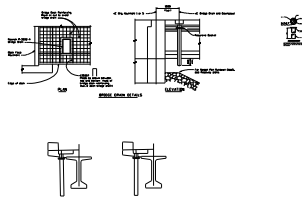
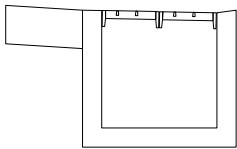
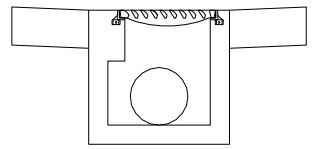
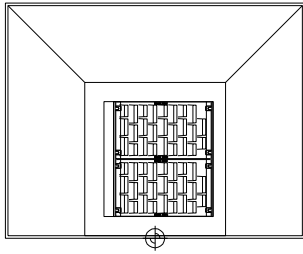
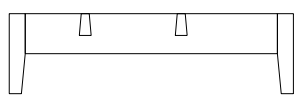
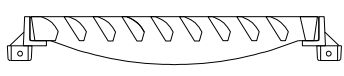
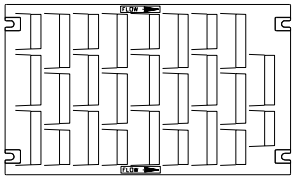
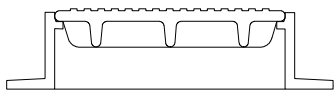
# CDOT BRIDGE CELLS

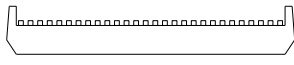
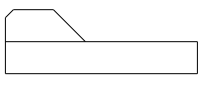
 <p>bolts_seven eights inch_ bolt with lock washer Graphic Cell</p>	 <p>bolts_seven eights inch_ hardened washer Graphic Cell</p>	 <p>bolts_seven eights inch_ lock washer Graphic Cell</p>	 <p>bolts_seven eights inch_ nut Graphic Cell</p>
 <p>bolts_seven eights inch_ nut and lock washer</p>	 <p>drainage_18cmp Graphic Cell</p>	 <p>drainage_asdrain_top Graphic Cell</p>	 <p>drainage_cpt45 Graphic Cell</p>
 <p>drainage_cpt90 Graphic Cell</p>	 <p>drainage_drain Graphic Cell</p>	 <p>drainage_m-604-25-box-front Graphic Cell</p>	 <p>drainage_m-604-25-box-side Graphic Cell</p>
 <p>drainage_m-604-25-box-top Graphic Cell</p>	 <p>drainage_m-604-25-front Graphic Cell</p>	 <p>drainage_m-604-25-side Graphic Cell</p>	 <p>drainage_m-604-25-top Graphic Cell</p>
 <p>drainage_manhole Graphic Cell</p>	 <p>drainage_mh-rung Graphic Cell</p>	 <p>drainage_mhstep-front Graphic Cell</p>	 <p>drainage_mhstep-side Graphic Cell</p>

# CDOT BRIDGE CELLS

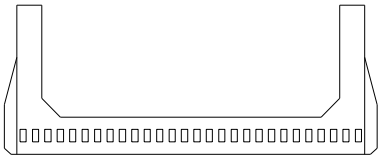

drainage\_mhstep-top  
Graphic Cell

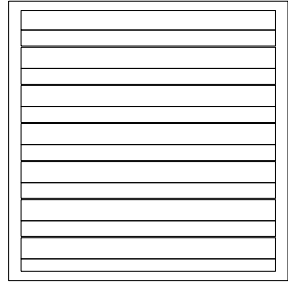

drainage\_r32875-grate  
Graphic Cell

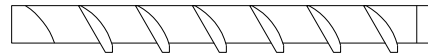

drainage-r32875-grate-side  
Graphic Cell

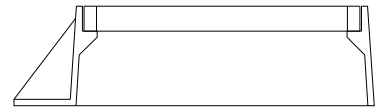

drainage\_r32875-side  
Graphic Cell

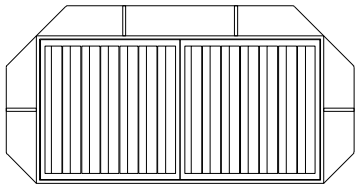

drainage\_r32875-top  
Graphic Cell

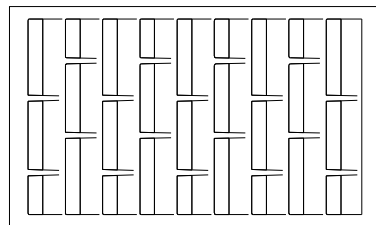

drainage\_r3580-gate  
Graphic Cell

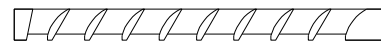

drainage\_r3580-grate-side  
Graphic Cell

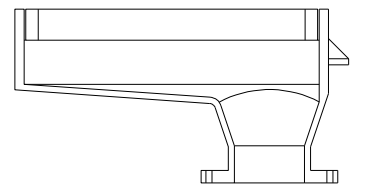

drainage\_r3922a-side  
Graphic Cell

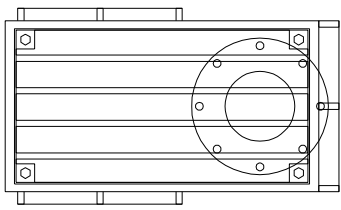

drainage\_r3922a-top  
Graphic Cell

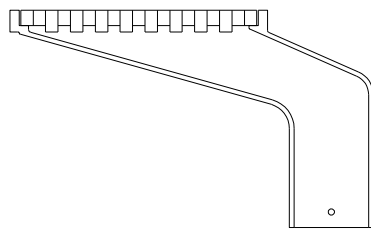

drainage\_r3936a-side  
Graphic Cell

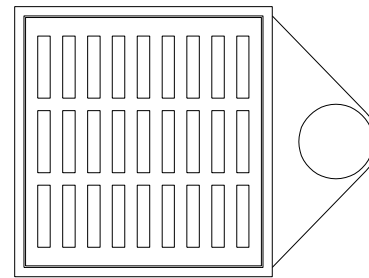

drainage\_r3936a-top  
Graphic Cell

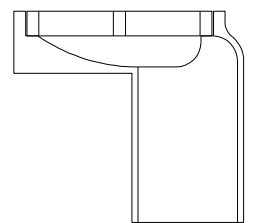

drainage\_r3940-side  
Graphic Cell

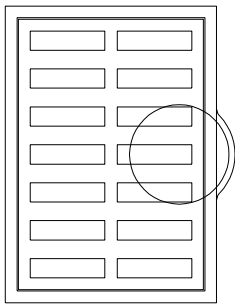

drainage\_r3940-top  
Graphic Cell

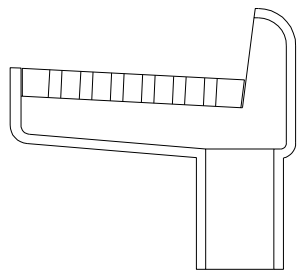

drainage\_r3948-side  
Graphic Cell

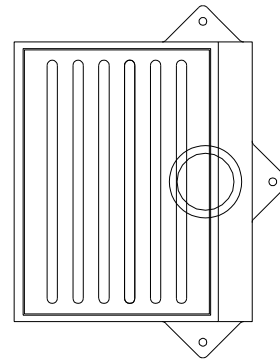

drainage\_r3948-top  
Graphic Cell

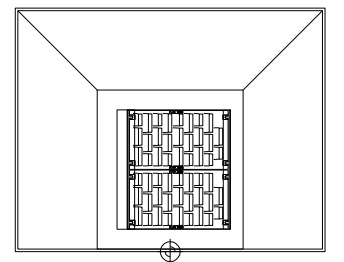

drainage\_type-r\_inlet-side  
Graphic Cell

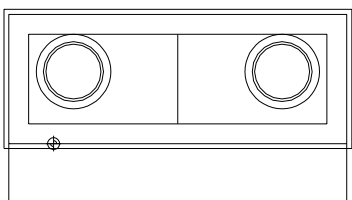

drainage\_type-r\_inlet-top  
Graphic Cell

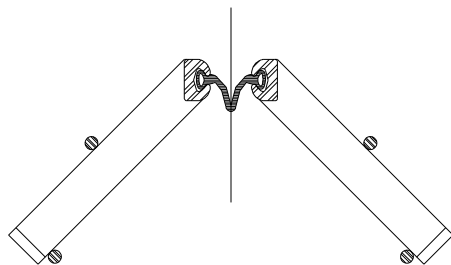

expansion\_frnt  
Graphic Cell

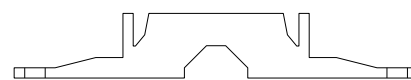



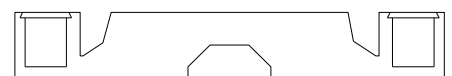

expansion\_gtd-type1  
Graphic Cell



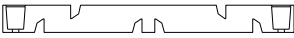

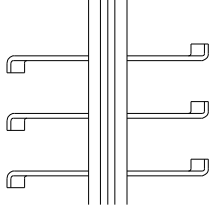

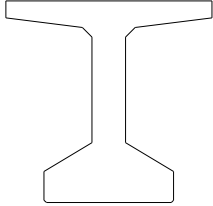
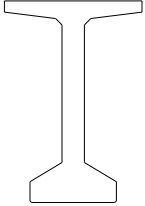
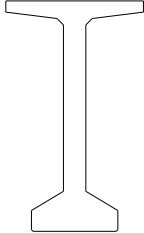
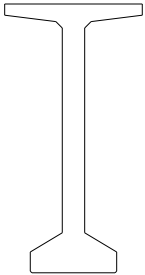
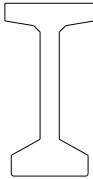
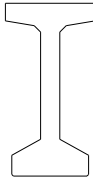
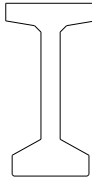
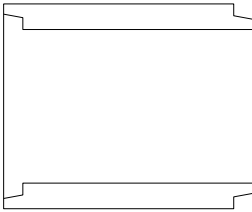
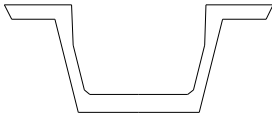
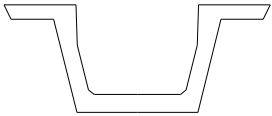
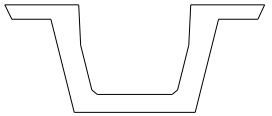
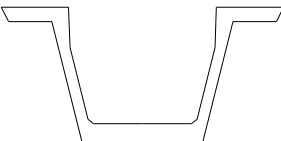
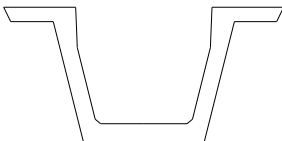
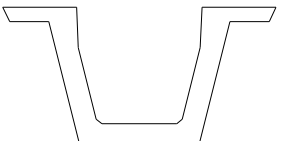
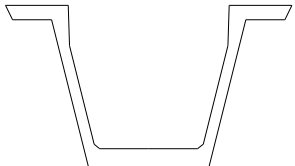
expansion\_gtd-type2  
Graphic Cell



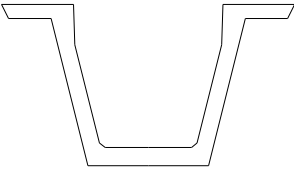
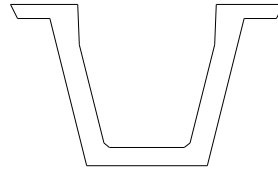
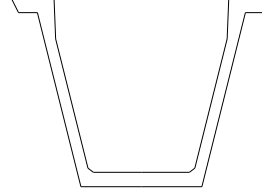
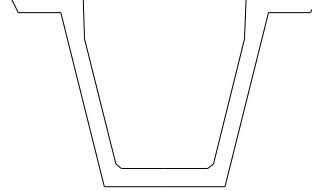
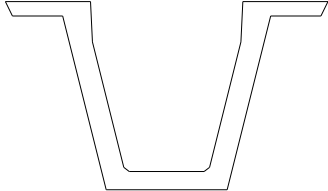
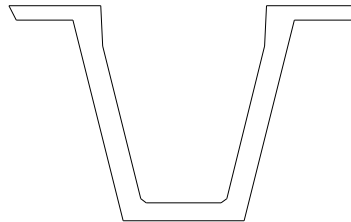
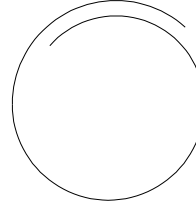
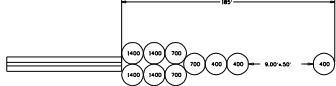
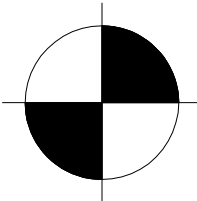

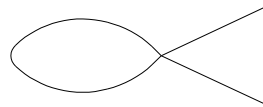

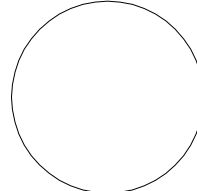
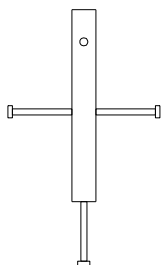
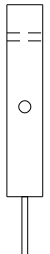
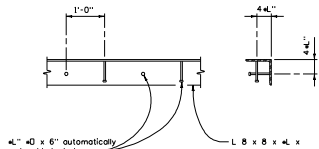
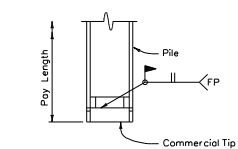
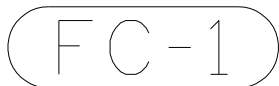
# CDOT BRIDGE CELLS

 <p>expansion_gtd-type4 Graphic Cell</p>	 <p>expansion_side Graphic Point</p>	 <p>expansion_ssa2 Graphic Cell</p>	 <p>expansion_top Graphic Cell</p>
 <p>girders_box42x24 Graphic Cell</p>	 <p>girders_bt42girder Graphic Cell</p>	 <p>girders_bt63girder Graphic Cell</p>	 <p>girders_bt72girder Graphic Cell</p>
 <p>girders_bt84girder Graphic Cell</p>	 <p>girders_g54_girder Graphic Cell</p>	 <p>girders_g68_girder Graphic Cell</p>	 <p>girders_g72_girder Graphic Cell</p>
 <p>girders_precast-box Graphic Cell</p>	 <p>girders_u48a Graphic Cell</p>	 <p>girders_u48c Graphic Cell</p>	 <p>girders_u48d Graphic Cell</p>
 <p>girders_u60a Graphic Cell</p>	 <p>girders_u60c Graphic Cell</p>	 <p>girders_u60d Graphic Cell</p>	 <p>girders_u72a Graphic Cell</p>

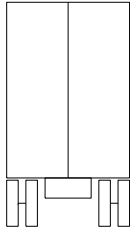
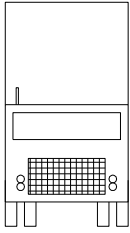
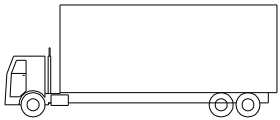
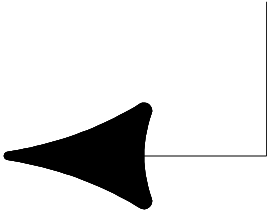
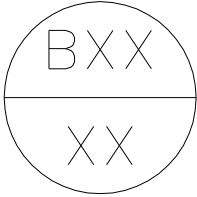
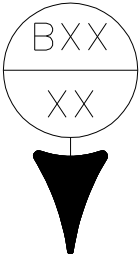
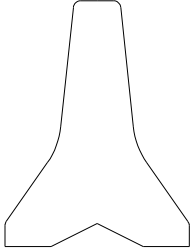
# CDOT BRIDGE CELLS

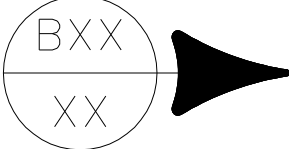
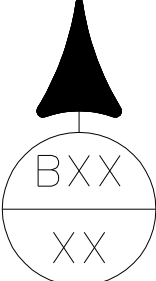
 <p>girders_u72c Graphic Cell</p>	 <p>girders_u72d Graphic Cell</p>	 <p>girders_u84a Graphic Cell</p>	 <p>girders_u684c Graphic Cell</p>
 <p>girders_u84d Graphic Cell</p>	 <p>girders_u96d Graphic Cell</p>	 <p>misc_Rebar_hoop Graphic Cell</p>	 <p>TYPICAL SAND BARREL ATTENUATOR LAYOUT</p> <p>misc_barrel-l Graphic Cell</p>
 <p>misc_bm Graphic Cell</p>	 <p>misc_bracket Graphic Cell</p>	 <p>misc_brkcurve Graphic Cell</p>	 <p>misc_bundle Graphic Cell</p>
<p>Ⓞ Piles</p> <p>misc_bcl Graphic Cell</p>	 <p>misc_dot Graphic Cell</p>	 <p>misc_epoxysymbol Graphic Cell</p>	 <p>misc_fenceanchor1 Graphic Cell</p>
 <p>misc_fenceanchor2 Graphic Cell</p>	 <p>PIER NOSE ANGLE DETAIL To be galvanized after fabrication.</p> <p>misc_noseangl Graphic Cell</p>	 <p>REINFORCING TIP DETAIL Use commercial tip APF Hard Bite 77600 or approved alternate.</p> <p>misc_reinftip Graphic Cell</p>	 <p>misc_revision Graphic Cell</p>

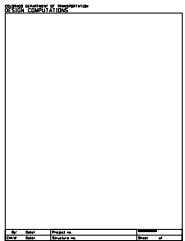
# CDOT BRIDGE CELLS

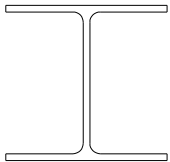
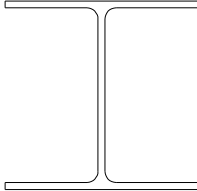
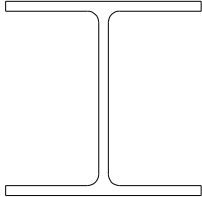
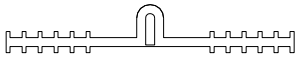
 <p>misc_truck Graphic Cell</p>	 <p>misc_truckback Graphic Cell</p>	 <p>misc_truckfront Graphic Cell</p>	 <p>misc_truckside Graphic Cell</p>
 <p>sectarw Graphic Cell</p>	 <p>sectub Graphic Cell</p>	 <p>sectdown Graphic Cell</p>	 <p>sectioning_conc-bar Graphic Cell</p>
 <p>sectitle Graphic Cell</p>	 <p>sectleft Graphic Cell</p>	 <p>sectright Graphic Cell</p>	 <p>sectup Graphic Cell</p>
 <p>sheets_8x11-land Graphic Cell</p>	 <p>sheets_8x11-port Graphic Cell</p>	 <p>sheets_initials-table Graphic Cell</p>	 <p>revision-table Graphic Cell</p>
 <p>steel sections_hp10x42 Graphic Cell</p>	 <p>steel sections_hp12x53 Graphic Cell</p>	 <p>steel sections_hp12x72 Graphic Cell</p>	 <p>waterstop-Tearweb_6 Graphic Cell</p>

# CDOT BRIDGE CELLS



waterstop\_6  
Graphic Cell

 waterstop_6 Graphic Cell			